

L A Z B O Y[®]

P R O F E S S I O N A L

**Chuze
Executive Chair**



MODEL OFD-LAZ553-BLK / OFD-LAZ553-GRY

PARTS



A Casters X5

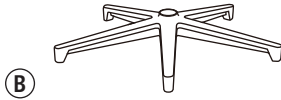

B Star Base X1



C Gas Lift X1

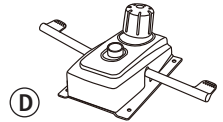

D Seat Plate X1



E1 Left Arm X1



E2 Right Arm X1

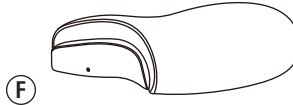

F Seat Cushion X1

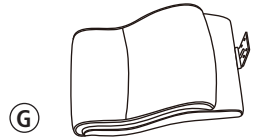

G Back Cushion X1



H 1-1/4" Screws X4



I 1" Screws X2



J 1-3/4" Screws X2



K 1-1/2" Screws with Spring Washers X4

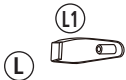

L Arm Inserts X2



R Arm Inserts X2



M Allen Key X1

Step 1

Place the star base (B) upside down and insert 5 casters (A) into the holes on the star base (B).

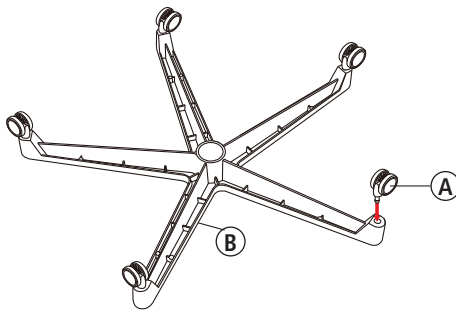

Step 2

Turn the star base (B) over and insert the gas lift (C) through the center hole on top of star base (B).

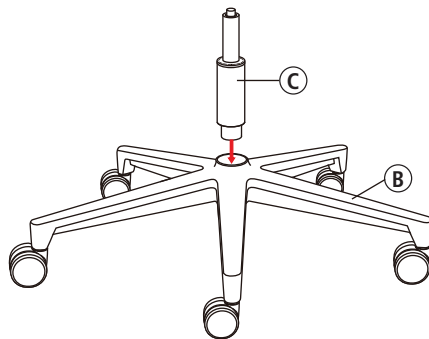

Step 3

Align the back cushion (G) with the seat cushion (F) and attach the back support plate onto the bottom of the seat cushion (F) by using 1-1/4" screws (H).

*Note: Do not tighten the screws completely.

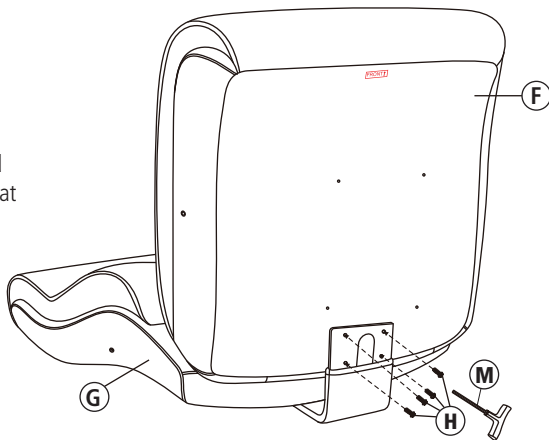

Step 4

Attach seat plate (D) to the bottom of the seat cushion (F) (with the front of the seat plate facing the front of seat cushion). Attach by using two 1-3/4" screws (J) for the front holes of the seat plate (D) and two 1" Screws (I) for the rear holes of the seat plate (D) and tighten the screws using allen key (M).

*Note: Tighten the screws completely.

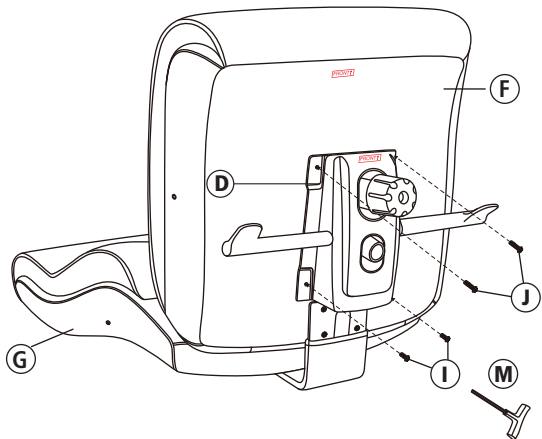

Step 5
Insert 1-1/2" screws with spring washers (K) into arm holes attaching arms (E1 & E2) (with the front of arms facing the front of seat cushion) to sides of seat cushion (F) and back cushion (G).
*Note: Tighten all the screws completely. Remember to tighten the back support plate screws.

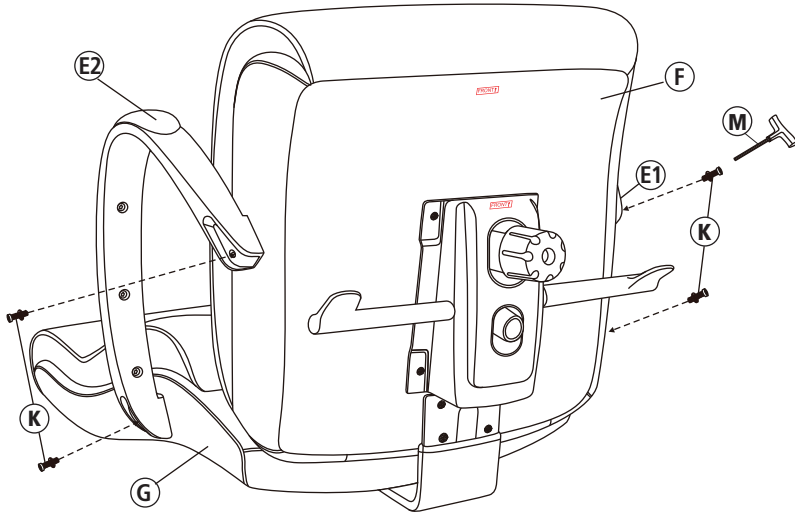

Step 6

Position the assembled chair upright with the seat plate (D) facing down. Insert the gas lift (C) into the center hole of the seat plate (D) and press down until fully engaged.

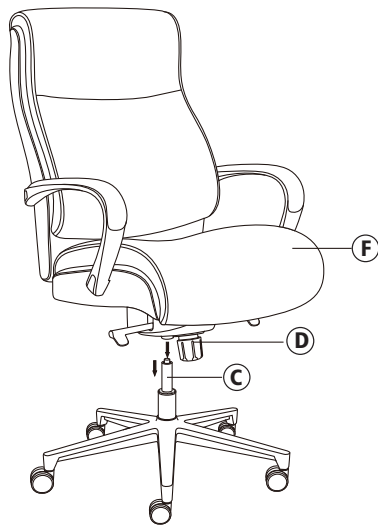

Step 7

Place the arm inserts (L1, L2, R1 & R2) into arm grooves once all screws have been tightened.

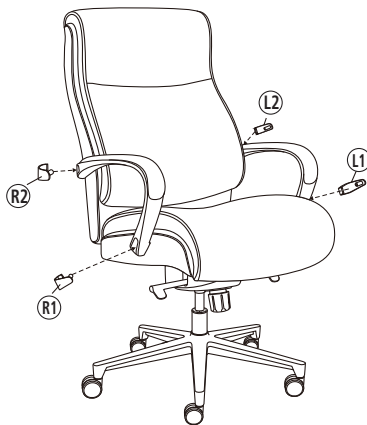

Operating Instructions

Function Instruction - 1

To Adjust Seat Height:

While seated, lean forward and reach under the right side of the chair to find the handle. Lift the handle and raise your body up slightly to allow the chair to rise to the desired height. Once desired height is reached, release handle to lock chair at desired height. To lower the seat, lift the handle while seated. The chair will descend until the handle is released or the chair reaches the bottom position.

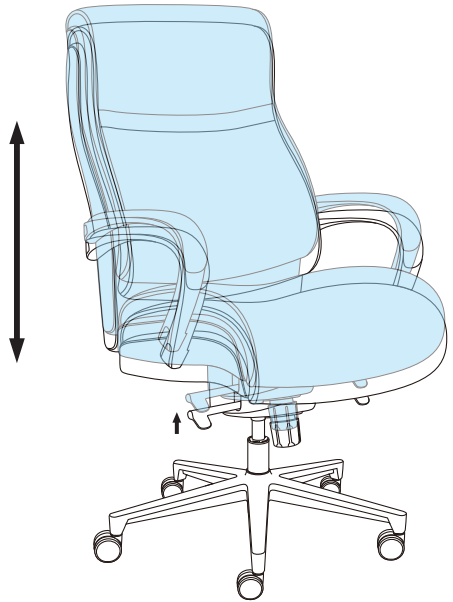

Function Instruction - 2

To Operate Tilt Lockout:

Reach under the left side of the chair to find the handle. Flip the handle down and lean back to allow the chair to tilt backwards. Flip the handle up to lock the chair angle while the desired position is reached.

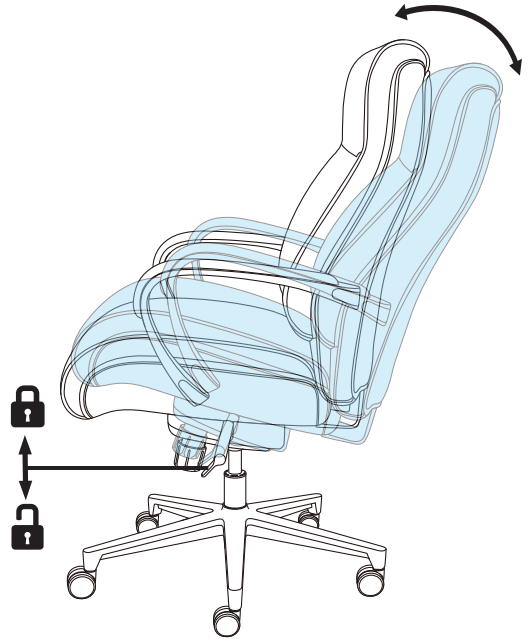

Function Instruction - 3 **To Adjust Tension on the Tilt:**

Reach under the front center of the chair, grasp the round knob (S) and turn it counter- clockwise to stiffen the tilt mechanism for a heavier user. Turn the knob (S) clockwise to loosen the tilt mechanism for a lighter user. Rotate the knob (S) until the desired resistance is reached.

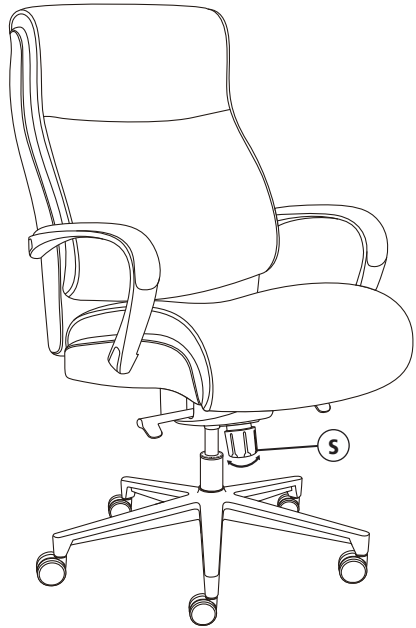

Function Instruction - 4

360° Swivel:

360° seat swivel.



L A **Z** B O Y[®]

P R O F E S S I O N A L



LA-Z-BOY is a trademark of La-Z-Boy Incorporated and is used under license to LF Products Pte Ltd.