

Ultra2 SYSTEM Installation Manual

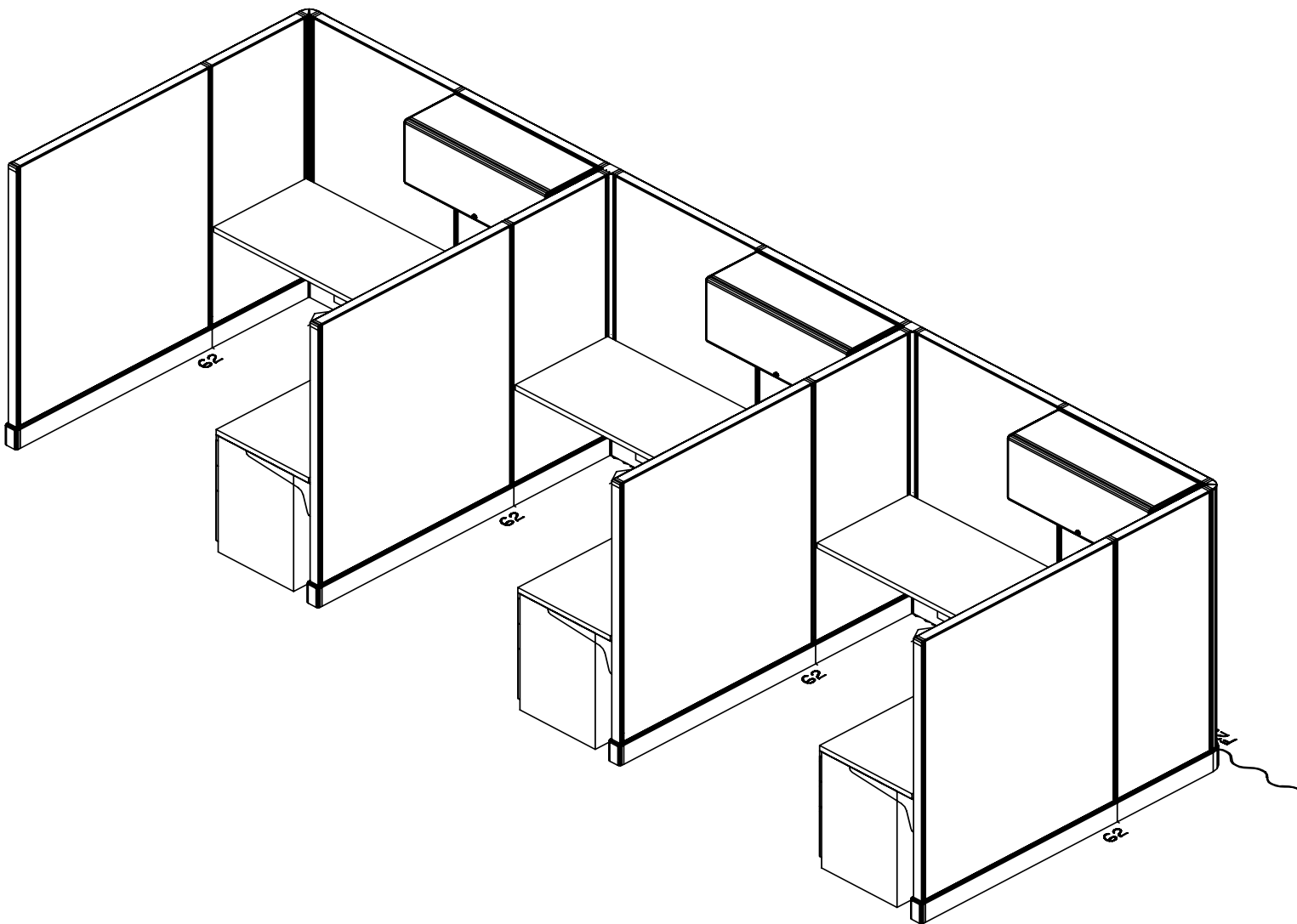

SYSTEM 2 INSTALLATION MANUAL

General Information.....	3
Safety & Support.....	4
Installation Tools	5
Staging & Installation.....	6

Panels & Connectors

Definitions	7
Panel to Connector: Same Height	8
Panel to Connector: Change of Height.....	9
Panel to Panel: Same Height.....	10
Panel to Panel: Change of Height.....	11
Panel to Panel: Installation at Inline Change of Height	12
Finished End	13
Finished End: Change of Height	14
Top Cap.....	15
Leveling Panels	16
Wall Starts.....	17

Electrical

Definitions & Wiring Diagram.....	18
Festoons	19
Receptacles.....	20
Ceiling Power Entry.....	21
Base Power Entry.....	22
Base Cover.....	23
Connector Trim	24

Finished End Trim	25
-------------------------	----

Upper Storage

Shelves	26
Flipper Door	27

Worksurfaces

Corner.....	28
Rectangular	29

Lower Storage

Pedestals	30
Lateral Files	31

Accessories

Cord Managers.....	32
LED Tasklight	33

GENERAL INFORMATION

This installation manual provides necessary information for the safe installation of OFD Ultra2 Panel product.

The Ultra2 product line is a modular panel system composed of panels, hanging and freestanding components and accessories designed to be precisely tailored to the office environment. It consists of products that are factory assembled and require installation only; and other products that are shipped as subassemblies for assembly during the installation process.

Ultra2 products are available with an 8-wire electric system that is listed with Underwriters Laboratories and comply with UL1286.

This product is considered portable furniture and is therefore subject to local fire, electrical and building codes; therefore, check with local building authorities before installation of the product.

It is the responsibility of the dealer and the installer to properly install this product according to this manual and generally accepted industry practices.



WARNING: Failure to follow the instructions in this manual can result in product damage, personal injury or both.



WARNING: Installation of electrical components should be done by a qualified electrician. Disconnect power prior to servicing the system.

SAFETY & SUPPORT

SAFETY NOTES

- Please read all WARNINGS and NOTES, as these are for your safety.
- Please read TIPS in the installation as helpful suggestions.
- Always use proper tools when installing.
- Keep your work area clean, clutter-free and safe during installation.
- Use eye protection when working under a workstation or when working with tools.
- Many products weigh more than 35 pounds. Use two or more people to safely lift, carry and install the products.
- When using tools, extension cords or ladders, use them in accordance to OSHA guidelines.
- Work safe, work smart.

SUPPORT CENTER

Should you have any questions or require assistance during the installation process, please telephone our support center:

PHONE (866) 648-3635

HOURS Monday - Friday, 8am - 5pm CST

INSTALLATION TOOLS

INSTALLATION TOOLS

The following tools are necessary for field assembly and installation of Friant's Novo product:

- Allen wrench 1/4"
- #2 Phillips head screwdriver
- #3 Phillips head screwdriver
- Screwdriver, med slotted
- Measuring tape (25' or more)
- Rubber mallet or dead blow mallet
- Carpenter's level (48")

The following tools will help speed up installations, but are not necessary:

- Drill (12v or more)
- Set of drill bits
- Set of screw bits #2 and #3
- 1/4" Allen bit for drill
- Wrench, open end 10mm (long handle is best)
- Pliers
- Carton knife
- Ratchet head 1/4" allen bit
- 6' step ladder
- Material handling carts

STAGING & INSTALLATION

STAGING

In an effort to make your project run more smoothly, the following is recommended:

1. Unload all products into a staging area on your job site and sort by product number.
2. Check in and count all products for accuracy and damage prior to the delivery truck leaving. Note any damages or shortages on the Bill of Lading before signing.
3. Notify the factory immediately of any shortages or damages (with photo to document).
4. Keep and maintain a clutter-free staging area — it will help speed up your assembly.
5. Protect all building walls with furniture pads or cardboard where product is leaning against them or in high traffic areas.

FOR SUCCESSFUL INSTALLATION

Keep these items in mind while installing product:

- Ensure that all products are level throughout the installation process and correctly attached.
- Check panels for stability after installation of all components. If needed, correct or adjust leveling or installation to fix stability.
- If needed, add additional support to panels to ensure stability.

DEFINITIONS

A **panel run** is any combination of two or more panels connected in a straight line.

Panels mounted at right angles to panel runs are called **support panels**. The minimum height for support panels should not be less than half the height of the tallest panel in the panel run. (Example: An 85" high panel run should have a minimum of a 47" support panel)

Load bearing walls, also known as structural walls, are constructed of materials such as poured concrete, concrete block or drywall, properly attached to metal or wood studs. Drywall must be at least 5/8" thick. Wall must be restrained at the floor and ceiling, and should be no more than 24" on center or 14' high. Under no circumstances does OFD accept responsibility for determination of the structural integrity of a load bearing wall.

A **loaded panel run** is any panel run that has product component of any kind attached to it. Also known as "load bearing side of a panel wall".



PANEL TO CONNECTOR — SAME HEIGHT

Connecting a Panel to a Connector

1. Using a 2, 3 or 4 way connector, loosen the draw block at the top (finished end) of the connector with your allen wrench. *IMAGE A*
2. Attach connector to the panel. The connector should easily fit over the panel wedge blocks on the end of your first panel. *IMAGE B*
3. Tighten connector onto panel. *IMAGE C*
4. Install connector top cap.



NOTE: All panels with electrically interconnected panels must be mechanically interconnected.

Connecting a Second Panel

1. Add a second panel onto the connector by loosening the other draw block at the top of the connector. *IMAGE A*
2. Attach panel to connector to begin your first panel run. Install the panel in a similar manner to above. *IMAGE B*
3. Tighten connector to panel. *IMAGE C*
4. You now have the start of your first station.



TIP: Start at a right angle condition in your layout. It is recommended that you identify the location using your plan to locate the connection in the office area.

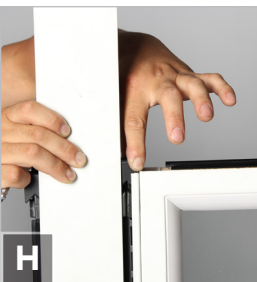
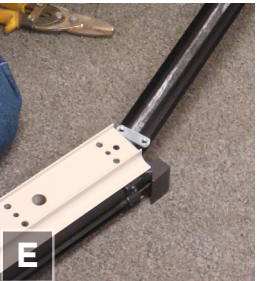
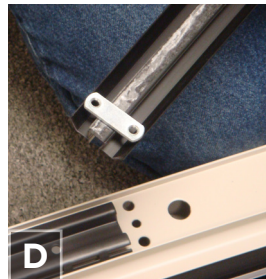
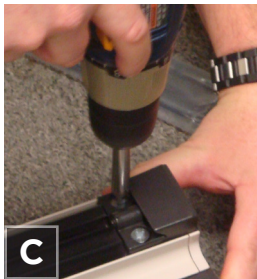
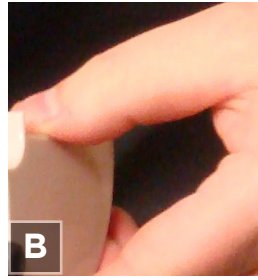

PANEL TO CONNECTOR — CHANGE OF HEIGHT

1. When installing a change of height connection, you must remove the black filler strip on the side of the connector you are going to attach the panel to. Always use the connector for the tallest panel you are attaching to.
2. To remove the filler strip, squeeze it at one end and pull toward you. *IMAGE A*
3. Remove the connector top cap by pressing gently on the location pin to release it. *IMAGE B*
4. Remove the top block assembly. *IMAGE C*
5. Using the back of the filler strip, push the threaded plate on to the sticky tape (align to fit in connector). *IMAGE D*
6. Using the filler strip as your guide, insert the threaded plate into the connector to the desired height connection. *IMAGE E*
7. Reinstall the connector top wedge block using the existing screws and parts. When the wedge block is securely tightened in place, gently pull the filler strip to release it. *IMAGE F*
8. Using a carton knife or a cutting tool, cut the filler strip to the appropriate length and reinstall the filler strip on the connector.
9. Attach the connector to the shorter panel. *IMAGE G*



NOTE: It is recommended to have two people for this part of the installation.

10. Tighten the panel wedge block. *IMAGE I*



WARNING: Make sure all wedge blocks and connectors are installed properly and securely before going on to the next part of the installation.

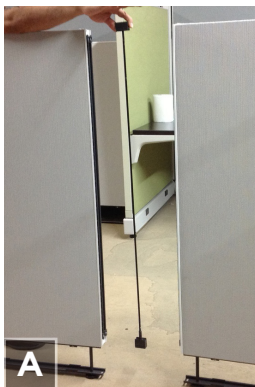

PANEL TO PANEL — SAME HEIGHT

Using your panel plan as reference, determine where the next panel goes. Install the panel in a panel run as follows.

⚠ WARNING: Failure to properly install panel runs or support panels can result in product damage, personal injury, or both.

The same height draw rod assembles two panels of the same height and facilitates installation of the top caps.

1. Using the draw rod, open the rod so it will loosely fit over the panel you have installed. Attach draw rod to existing panel run. IMAGE A, B, C
2. With the help of another installer, install the next panel in a straight line. IMAGE D
3. Align panel and attach draw rod. Make sure the bottom and the top of the panel are aligned with your other panel; adjust the panel glides, if needed. IMAGE D
4. Tighten draw rod and block to connect the two panels. Check draw rod top and bottom block to ensure they are seated correctly. IMAGE E, F

⚠ WARNING: Always check top and bottom blocks on draw rod to ensure they are seated correctly.



PANEL TO PANEL — CHANGE OF HEIGHT

Change of height draw rod includes a draw rod and a hanger rail of the same height.

1. Remove top block and hanger rail from taller panel.
IMAGE A, B, C
2. Replace taller hanger rail with shorter hanger rail to match the height of the lower panel. IMAGE D
3. Install the panel top block to match the height of the lower panel. IMAGE E
4. Align both panels and secure the shorter panel to the taller panel by tightening the draw rod. IMAGE F

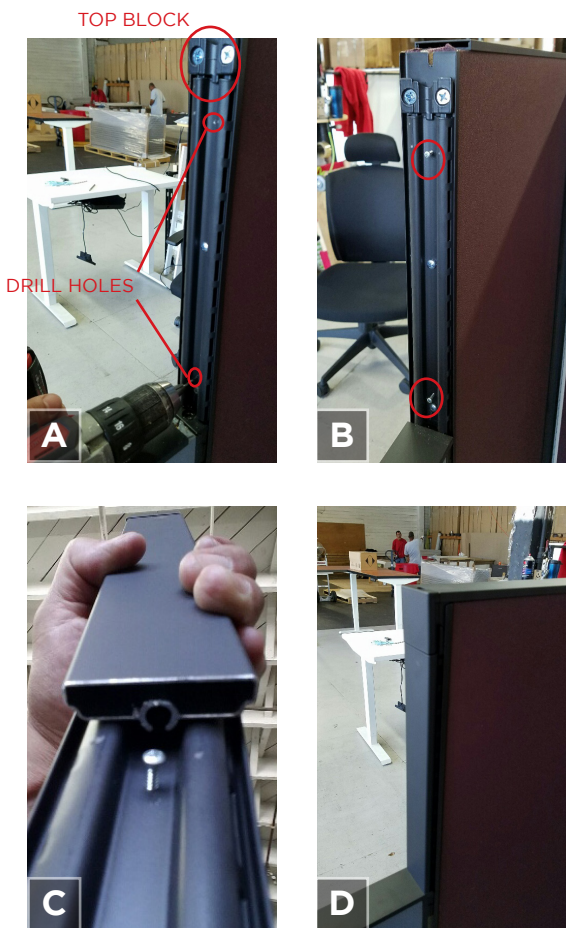

PANEL TO PANEL - INSTALLATION AT INLINE CHANGE OF HEIGHT

Special, non-standard condition: Only applies when overhead will be installed on taller panel.

Before step 1 below, you will have already installed the two panels of different heights, using the shorter draw rod and hanger rail included with the draw rod change of height package (FDRCH.XX)

**Note: This special installation requires the following parts: (a) Finished end (F2FE.XX) in lieu of finished end, change of height (FFECH). (b) Additional Panel wedge block (FASA03-0-DT)

1. Cut the taller hanger rail (removed prior to installation of panel) to the size needed. IMAGE A
2. Install the panel top block (FASA03-0-DT) Shown in photo A. IMAGE A
3. Drill (2) holes through hanger rail, side rail and into panel blank. IMAGE A
4. Install (2) screws, leaving the head of the screw protruding. IMAGE B
5. Cut finished end (F2FE.XX) to size needed.
6. Slide modified finished end onto the screws. IMAGE C
7. Final installed product. IMAGE D



WARNING: It is very important at this point in the installation to re-check all connections to ensure safety and security.



FINISHED END

1. Loosen the top of the finished end (1 hole) with the allen wrench. IMAGE A
2. Set the bottom of the finished end (3 holes) on the bottom wedge block on the panel. IMAGE B
3. Move the finished end and set over the top block of the panel and tighten. IMAGE C & D



WARNING: It is very important at this point in the installation to re-check all connections to ensure safety and security.



FINISHED END — CHANGE OF HEIGHT

1. Take the finished end and place it upside-down on the connector. Measure the length to the top and draw a line to mark for cutting. *IMAGE A*
2. Using a small hack saw or other appropriate cutting tool, cut the finished end to length. *IMAGE A*
3. Remove the paper from the tape and align with the change of height location on the connector. Press it into place. *IMAGE B*

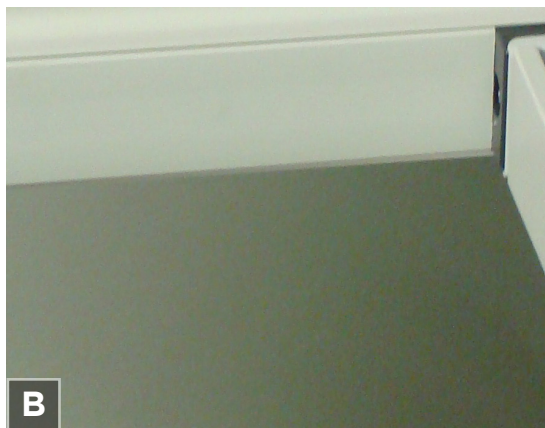

WARNING: It is very important at this point in the installation to re-check all connections to ensure safety and security.



TOP CAP INSTALLATION

Before installing the top caps, please ensure that all connectors have been installed and all panels are leveled.

1. Angle top cap to engage one side first, then rotate toward the other side and snap the top cap onto the top cap holder. IMAGE A
2. Check to make sure that the top cap is leveled and installed securely.

Example of Incorrect Leveling:

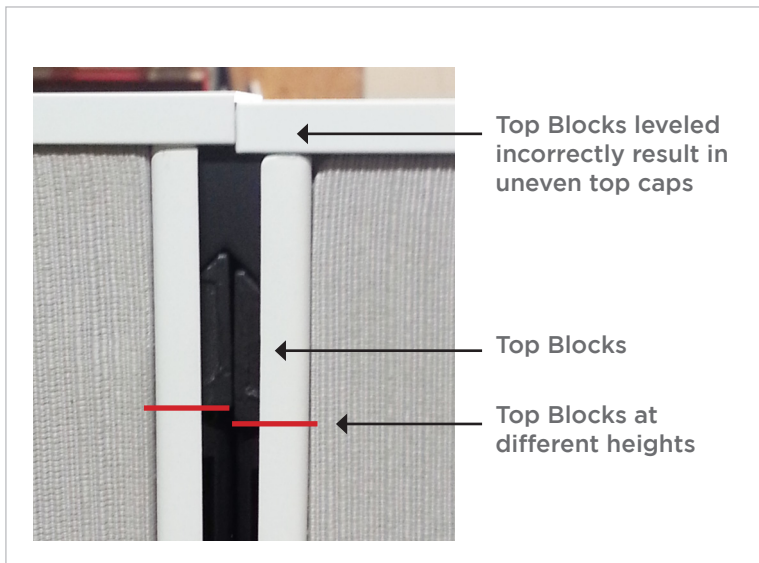

Example of Correct Leveling:

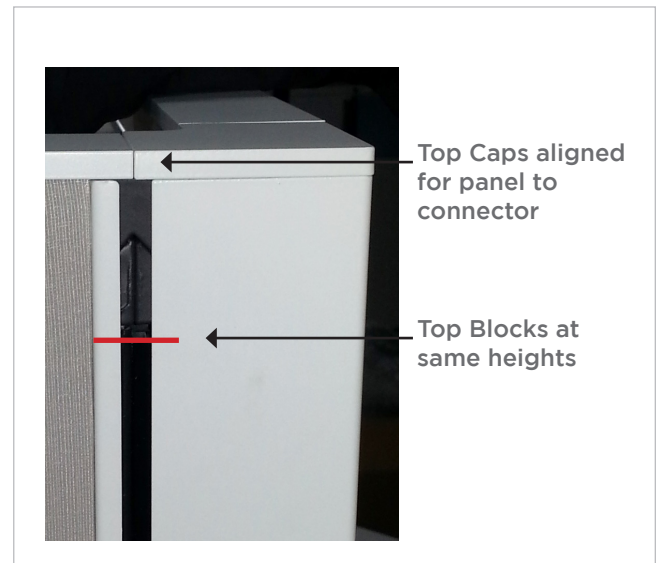

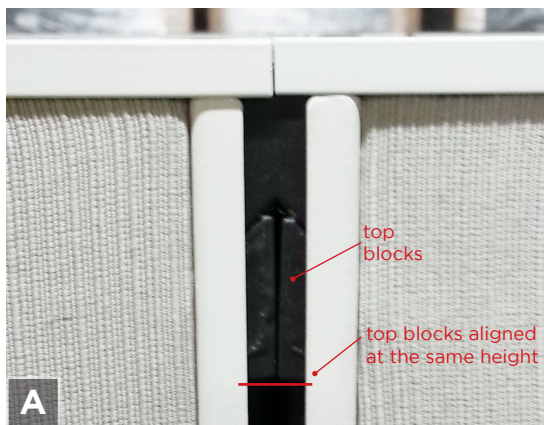

LEVELING PANELS

It is essential that each panel be properly leveled during the installation process.

1. Level as needed, using a 10 mm wrench to move glide up or down.
2. Realign your panels for location and square in the installation. Refer to your installation plans for location.
3. A key indicator of proper leveling is that the top blocks (at panel-to-panel or panel-to-post connection) are at the same height. IMAGE A
4. Double check your work now; it will save time later. Level both to the ceiling, but also visually. IMAGE B

TIP: Use the ceiling tiles to help line up the visual aspects of your installation.

Example of Incorrect Leveling:

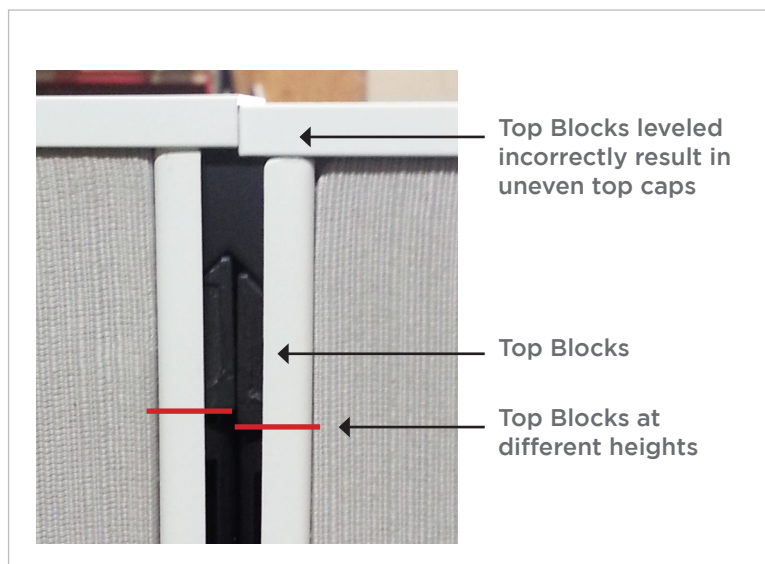

Example of Correct Leveling:

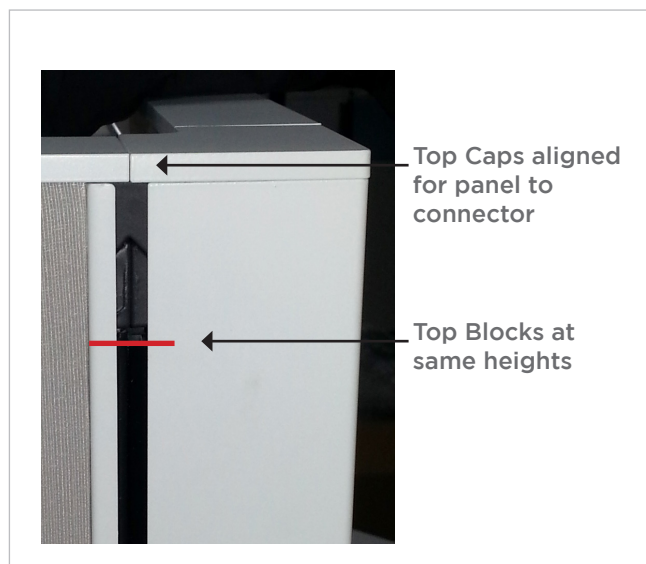

WALL STARTS

Wall start applications require some additional tools. The most important are a good tape measure, level and drill.

The wall should be reinforced to prevent damage or injury.

1. Locate on your plan the wall start. Measure the wall, and very lightly with a pencil, mark the location of the wall start.
2. Take a panel and level it to the wall to determine the mounting height of the wall start. Lightly mark the wall at the top of the panel.
3. Locate the top 2 holes of the wall start and mark on the wall for positioning. Install your fastener to the wall at this location and install the top of the wall start.
4. Level the wall start and repeat this step to attach the bottom block.
5. Cut and attach the filler strip as needed.



WARNING: You must use appropriate anchors for attaching the wall start to the wall. These anchors will vary depending on the field conditions. Be careful not to damage corner beads for drywall; it is strongly suggested you space off the edge of drywall corner 2" to prevent damage.

DEFINITIONS

Power harnesses are the power distribution parts that carry all power through the system. It comes pre-installed in the panel base.

Power entry, either base feed or ceiling feed are the power distribution parts designed to connect to the existing building power.

Receptacles are the outlet plugs designed for installation in the power harness to provide power within the work space.

Festoons are used to carry the electrical power from power harness to power harness.

A **qualified electrician** is an individual either licensed or recognized by the local building code authorities to properly wire the Ultra2 power system to the existing building power.

WARNING: Never attempt to install the power entries on this system without a qualified electrician. Attempting to do so can result in electric shock, personal injury, or death.

WARNING: All electrical connections must be securely engaged. Loose connections can cause fire and/or electrical shock.

Wiring Diagram

This general wiring diagram is for both the ceiling infeed and the base power entry. The diagram will vary depending on local codes and the building's general wiring type and specific applications for use. In general, the WYE type application is used in most single phase office type applications. Before wiring, you should always consult a qualified electrician for the specific diagram to use in your facility and use only a qualified electrician to wire these power entries.

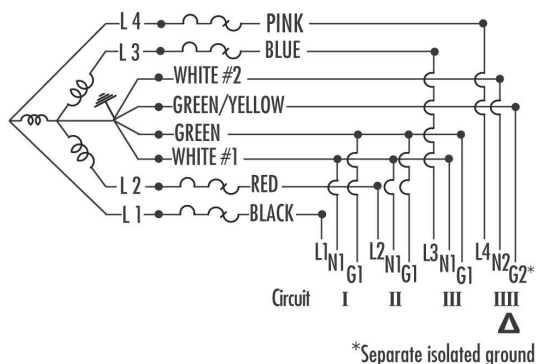

Ultra2 is rated for connection to a 3 phase system.
Rating 120/208V, 3-PH WYE, 60-hz, 20 amp (CSA 15amp) multi-wire branch circuit

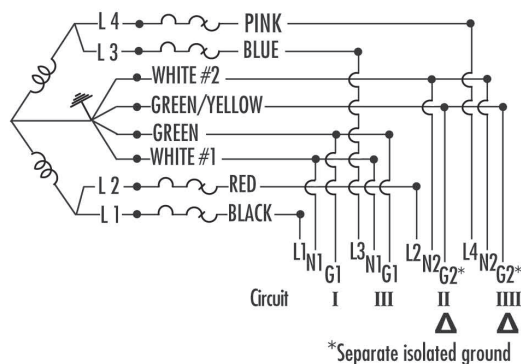

Ultra2 is rated for connection to a ground 120/240V,
1-PH 60-hz, 20 amp multi-wire branch circuit.

FESTOON INSTALLATION

Examples of Correct Festoon Installation:

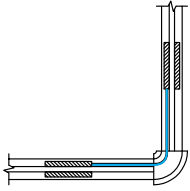

Correct 2-Way

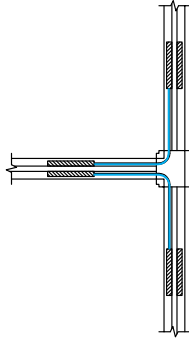

Correct 3-Way

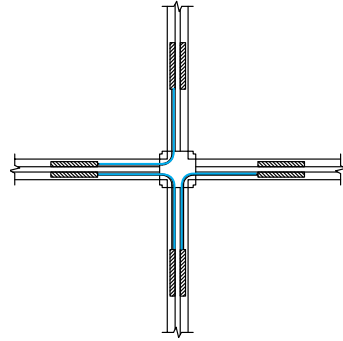

Correct 4-Way



A

Once you have installed the panels and connectors and have leveled the system, you can begin to install the festoons.

There are two types:

- Panel to panel festoon
- Panel through post festoon

1. Place the festoon gently onto one end of the panel power harness. **IMAGE A**
2. Push until it locks into the silver locking clip. Make sure it is securely locked into place. **IMAGE B**

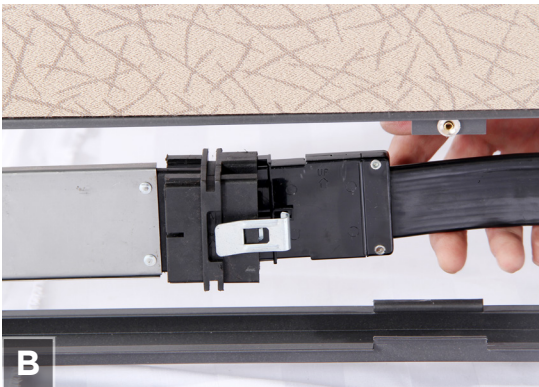

B



NOTE: Longer 23" festoons are used to carry the electrical power through a 3- or 4-way connector post in a straight line.



WARNING: This energy system is designed to be installed in accordance with all local building codes. It must not be installed contrary to these codes for any reason.



A



B



C



D

RECEPTACLE INSTALLATION

1. Insert the receptacle into the side of the power harness, with the number in the “up” position. IMAGE A



NOTE: The arrow on the festoon must be in the “up” position. Do not force the connection.

2. Align the lower tab on the receptacle with the mechanical connection on the power harness. IMAGE B
3. Secure the connection, sliding the receptacle until it locks into the spring clip via the mechanical connection, locking the receptacle into place. IMAGE C



WARNING: Receptacle must be secured at this point in the installation. Failure to do so can cause an electrical hazard.



WARNING: Failure to follow these instructions for connecting the festoon can cause a short circuit and may result in product damage, electrical shock, property damage or personal injury.

CEILING POWER ENTRY



WARNING: Disconnect power before servicing. All electrical connections must be fully engaged and locked. A loose connection can cause fire and/or electrical shock.



NOTE: The installation of the power entries, both ceiling feed and base power entry, must be made by a qualified electrician. The purpose of this installation instruction is to assist you in working with the electrician to have this product installed. Under no circumstances should this be attempted by a person not recognized by local building authorities as a qualified electrician.

1. Ceiling power may be attached at the end of a panel or to a connector:

END OF PANEL:

Connect the draw rod to the end of the panel and ceiling power entry hardware the same way you would a panel to panel connection. See Panel & Connector installation, page 9.

CONNECTOR:

Attach hardware on the ceiling power entry to connector the same way you would a panel to connector installation. See Panel & Connector Installation, page 9.

2. To install the ceiling feed, gently push it into the end of the power harness. Make sure the locking clip is engaged and secured.
3. Connect cable into the ceiling at a junction box in accordance with local building codes and the wiring diagram below.



WARNING: Power entries should not be installed by any person(s) other than a qualified electrician. Attempting to do so can result in electric shock, personal injury, product damage, property damage or death.

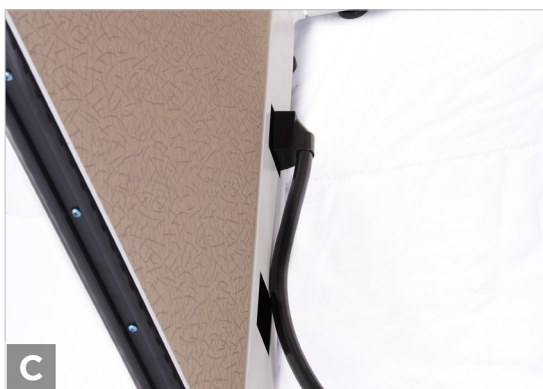
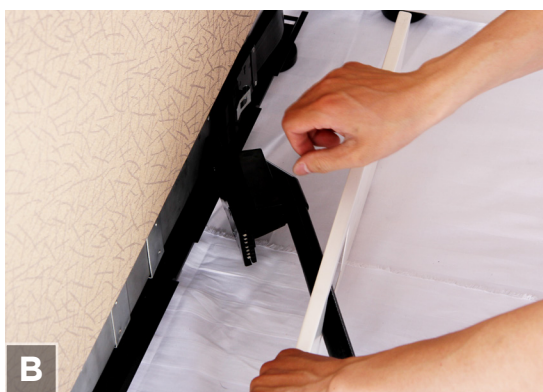

BASE POWER ENTRY

⚠ WARNING: Disconnect power before servicing. All electrical connections must be fully engaged and locked. A loose connection can cause fire and/or electrical shock.



NOTE: The installation of the power entries, both ceiling feed and base power entry, must be made by a qualified electrician. The purpose of this installation instruction is to assist you in working with the electrician to have this product installed. Under no circumstances should this be attempted by a person not recognized by local building authorities as a qualified electrician.

1. To install the base power entry, gently push it into the side of a power harness at a duplex location. Make sure the power harness snaps into the spring loaded mounting bracket. IMAGE C
2. Connect the cable into the wall or floor at a junction box in accordance with local building codes and the wiring diagram. IMAGE D

⚠ WARNING: Power entries should not be installed by any person(s) other than a qualified electrician. Attempting to do so can result in electric shock, personal injury, product damage, property damage or death.



TIP: Feed the cable through your raceway at this point. It will help in the installation of the product.



BASE COVER INSTALLATION

Once the electrical components have been installed as needed and the connector trim covers are on, you can begin installation of the raceway covers.



TIP: At this point, you may want to encourage the data and telephone installers to lay their cable. It can be done later, but generally works best at this point.

1. Gently push the raceway cover, starting at one end onto the rolled edge of the raceway.
2. Roll the cover up into position to lock into the lower edge of the panel.
3. Gently tuck the lip on the top of the raceway cover under the edge at the bottom of the panel
4. When finished, the raceway cover will stay in place by itself.



CONNECTOR TRIM

Connector trims are for 2-Way and 3-Way connectors only; 4-Way connections do not have a trim.

1. Gently place the ends of the connector trim over the tabs on the end of the connector stem. You may need to bend the cover slightly to place it over the tab, but use caution to avoid breaking the cover. *IMAGE A*
2. Once the cover is in place, rotate the cover upward and lock into place at the upper part of the connector stem.

IMAGE B



FINISHED END TRIM

1. Place the tabs on the bottom of the end cap into the holes on the raceway. *IMAGE A*
2. Rotate the end cap to lock it into the tab at the bottom of the panel. Adjust tab with a flat tip screwdriver if needed for a firm fit. *IMAGE B*

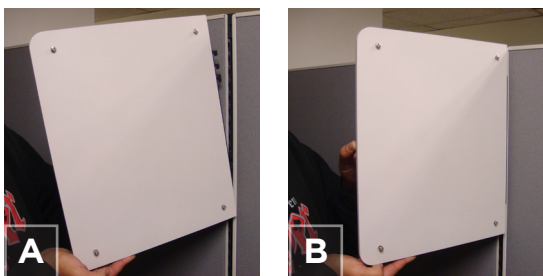

SHELF INSTALLATION

The installation below applies to open shelves as well as shelves for adding on a flipper door.

Shelf Ends

1. Position the shelf end over the frame or wall strip at the required height. Shelf mounting screws must be at the bottom edge and face the opposite shelf end. *IMAGE A*
2. Rotate the shelf end back. Insert the top tab on each shelf end hanger bracket into the slots on the frame or wall strip. Rotate the front of the shelf end down to fully engage all clips into slots. *IMAGE B*
3. Lock shelf ends in place by pushing down until all clips are fully seated. *IMAGE B*

Shelf Pan

If installing a flipper door to this shelf, the shelf ends require **8 mounting screws (4 each)**. If installing only as an open shelf, the shelf ends require **4 mounting screws (2 each)**.

1. Loosen the shelf mounting screws at the bottom edge of each shelf end.
2. Position the shelf between the shelf ends, lining up the slots on each side of the shelf pan with the mounting screws on each shelf end. *IMAGE D*
3. Lower the rear of the shelf pan onto the rear screws, then lower the front of the shelf pan onto the front screws.
4. Press down on the shelf and ensure the shelf pan is fully seating on the mounting screws. *IMAGE D*
5. Tighten all mounting screws. *IMAGE E*



NOTE: If installing a flipper door to this shelf, continue with the instructions on the next page.



A



B



C

FLIPPER DOOR INSTALLATION



NOTE: Before proceeding with the flipper door installation, check to make sure the shelf pan is securely locked onto the shelf ends.

1. Loosen the mounting screws at the top edge of each shelf end.
2. Setup the flipper door in the open position, and lower the rear slots in the door guides over the rear mounting screws on the top of each shelf end. *IMAGE A*
3. Push the flipper door back until the front slots in the door guides drop over the front mounting screws on the top of each shelf end. *IMAGE B*
4. Make sure the flipper door is fully seated on the mounting screws. *IMAGE C*
5. Tighten all mounting screws. *IMAGE C*

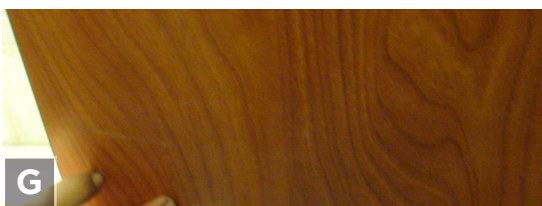
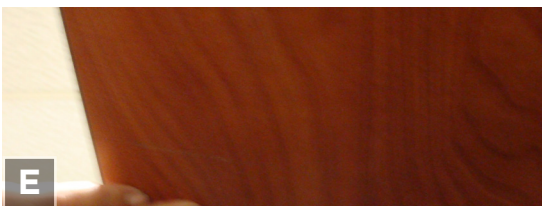
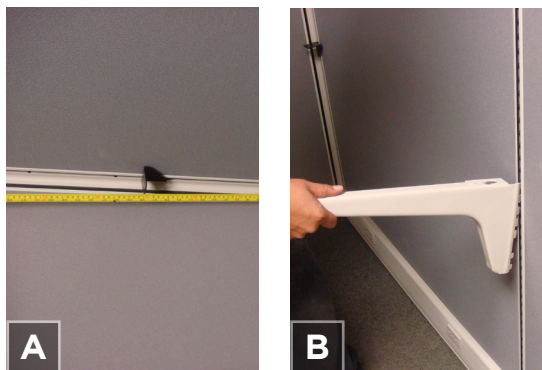

CORNER WORK SURFACE



WARNING: All worksurface support used to support the same worksurface must be mounted at the same height.



NOTE: Corner worksurfaces should be installed before installing adjacent worksurfaces.

1. Install the corner bracket into the corner at the desired height. Ensure all bracket hooks are fully seated in the slots. *IMAGE A*
2. Insert the tab on the top hook of the cantilever bracket into the hanger frame slot at the desired height. *IMAGE B*
3. Rotate the bottom of the cantilever bracket into the frame to engage all hooks. Repeat the procedure for the cantilever on the other side of the worksurface.
4. Push down on all worksurface supports to ensure all hooks are fully seated in the slots. *IMAGE C*
5. Pre-install one shoulder screw and pin in the pre-drilled holes on the underside of the worksurface, either on the left or right side. Do not install the other side yet.
6. Drop the worksurface onto the corner bracket and the cantilever brackets, by inserting the pre-installed screws (either left or right) on the key slot at the back of the cantilever bracket.
7. Drop the front pin pre-installed in the worksurface into the cantilever bracket.
8. Secure the opposite end, from the underside of the worksurface, with a shoulder screw and pin.
9. Level worksurface by adjusting the leveling screw at the front of the cantilever bracket.
10. Install adjacent worksurfaces as required and attach ganging plates between adjacent worksurfaces.



A

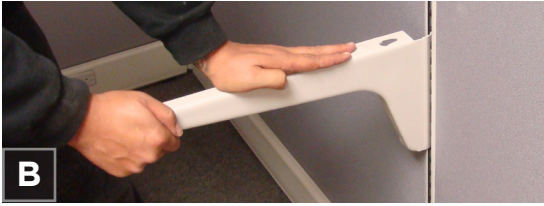

B

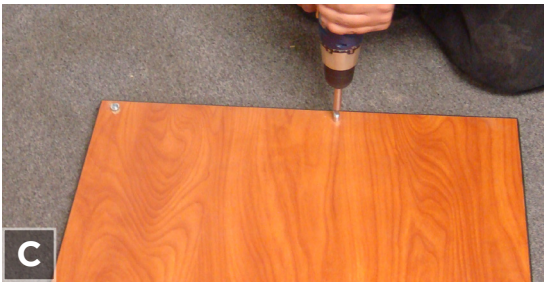

C



D

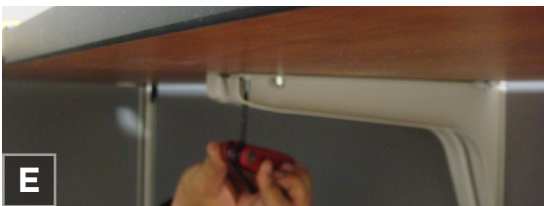

E

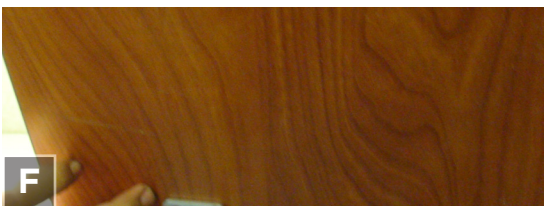

F

RECTANGULAR WORKSURFACE



WARNING: All worksurface support used to support the same worksurface must be mounted at the same height.

1. Install the cantilever bracket on the hanger frame by inserting the tab on the top hook of the cantilever bracket into the hanger frame slot at the desired height. Rotate bottom of cantilever bracket into the hanger frame to engage all hooks. Repeat procedure for cantilever on the other side of the worksurface. IMAGE A



NOTE: For worksurfaces 60" to 72" wide, install a center support on the center hanger frame at the same height as the cantilevers on the right and left sides.

2. Push down on all worksurface supports to ensure all hooks are fully seated in slots. IMAGE B
3. Install shoulder screws and pins provided onto worksurface in pre-drilled holes. Install worksurface by inserting shoulder screws into keyhole slots in rear of cantilever brackets, and push worksurface back until pins engage the front holes in the cantilever brackets. IMAGE C
4. Install worksurface on the cantilever brackets by inserting shoulder screws into keyhole slots in rear of the cantilever brackets. Push worksurface back until pins align with holes at the front of the cantilever bracket. Drop front of worksurface into place. IMAGE D
5. Level worksurface by adjusting the leveling screw at the front of the cantilever brackets. IMAGE E
6. Install adjacent worksurfaces required. Attach ganging plates between adjacent worksurfaces on underside of the worksurface. IMAGE F



NOTE: Rectangular worksurfaces spanning two or more panels require a center support provided.



PEDESTALS

All pedestals (except mobile pedestals) require attachment to the worksurface they are supporting.



TIP: It is important that you check your pedestal height in worksurface installation. If the height is incorrect you will have to adjust the glides on the pedestal or reset the height of the worksurfaces accordingly.

1. Open the drawer on your pedestal. The key is attached to the top of the pedestal for shipping. *IMAGE A*
2. Remove the drawers by lifting the dislodging brackets on each side of the drawer at the front of the suspensions, and pulling forward. *IMAGE B*
3. With the pedestal in place, attach mounting screws provided into the locations at the front and rear of the pedestal and tighten. *IMAGE C*
4. Carefully reinsert the drawers back into the track.



TIP: Always recheck the drawers for proper operation after installing the pedestal, and check to ensure the lock is working properly.

B



C

LATERAL FILE INSTALLATION



WARNING: An improperly installed Lateral File can become wobbly or tip over causing serious injury. Follow all instructions in this manual for correct installation, use and maintenance.



A

SUPPORTING 2 DRAWER LATERAL FILE

All supporting lateral files require attachment to the worksurface they are supporting.



TIP: It is important that you check your lateral height in worksurface installation. If the height is incorrect you will have to adjust the glides on the lateral or reset the height of the worksurfaces accordingly.

1. Open the drawer on your pedestal. The key is attached to the top of the lateral for shipping. IMAGE A
2. Remove the drawers by lifting the dislodging brackets on each side of the drawer at the front of the suspensions, and pulling forward. IMAGE B
3. With the lateral in place, attach mounting screws provided into the locations at the front and rear of the lateral and tighten. IMAGE C
4. Carefully reinsert the drawers back into the track.



TIP: Always recheck the drawers for proper operation after installing the lateral, and check to ensure the lock is working properly.

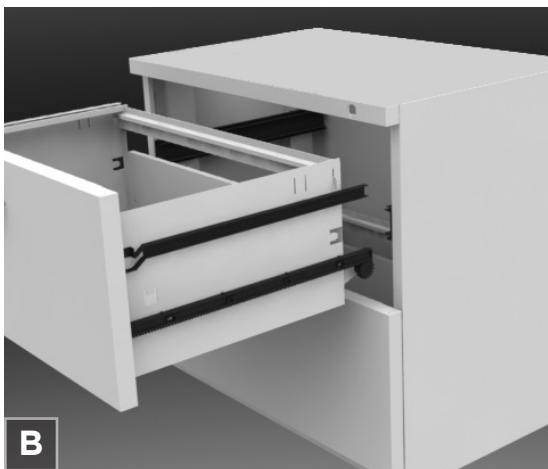

B

FREESTANDING 2, 3 & 4 DRAWER LATERAL FILE - INSTALLING, LEVELLING AND ANCHORING

1. Make sure cabinet is empty.
2. Position cabinet(s) into desired location.
3. Align/level cabinet(s) side-to-side.
4. On carpet, adjust glides such that front of the cabinet is 1/4th higher than the rear. On uncarpeted floors, the front should be 1/8th higher than rear.
5. Freestanding 3 or 4 drawer lateral files must be bolted together or to a wall.
6. Check the cabinet for proper operation. Drawers and doors should open and close smoothly and be evenly aligned with the frame.
7. When loading files in the lateral file always load the bottom drawer(s) first.



C



Task light cord without cord manager in workstation.

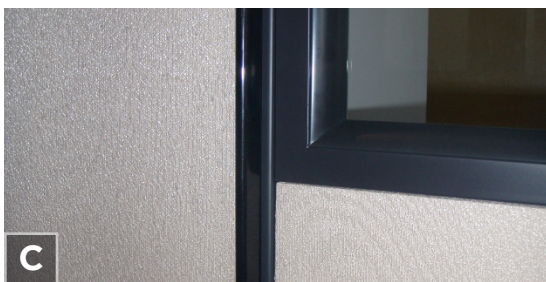

CORD MANAGERS

The cord manager is sold in 24" lengths and designed to be cut to length in the field and placed to manage and control cables in the stations.

1. Insert cord manager in workstation. IMAGE A
2. Insert cord manager into hanger frame. IMAGE B
3. Cord manager in place, neatly hiding cords. IMAGE C

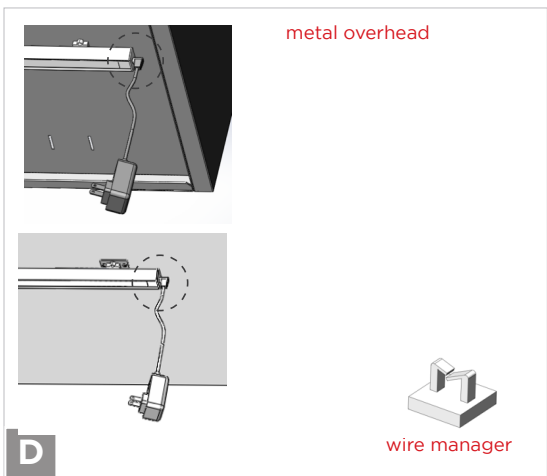
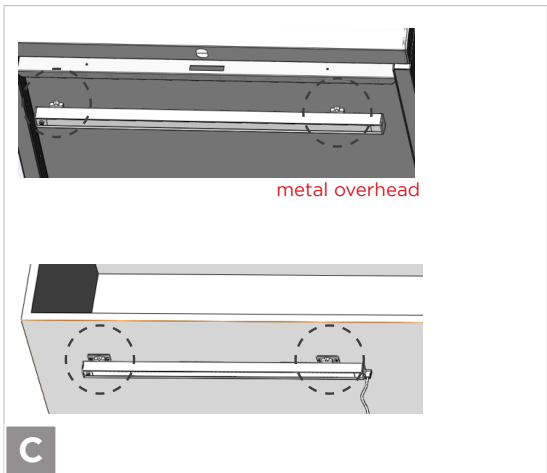
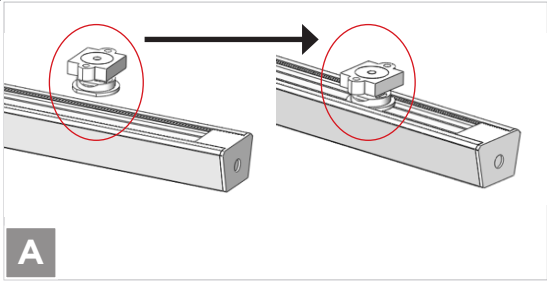

LED TASKLIGHT



NOTE: Installation differs slightly for attaching to a wood overhead vs metal overhead. Be sure to skip step #2 if attaching to a metal overhead.

1. Snap the magnet into the back of the LED tasklight – one on each end. *IMAGE A*
2. ***Skip to the next step if attaching the LED tasklight to a metal overhead.*** Install the metal plates to the bottom of the wood overhead using screws provided. Ensure the metal plates are spaced appropriately and aligned straight when installing. *IMAGE B*
3. Attach the LED tasklight to the metal surface. *IMAGE C*
4. Plug the power adapter into the LED tasklight and use the wire managers as necessary. *IMAGE D*