

Assembly and Operating Instructions

Electric table base

VL22

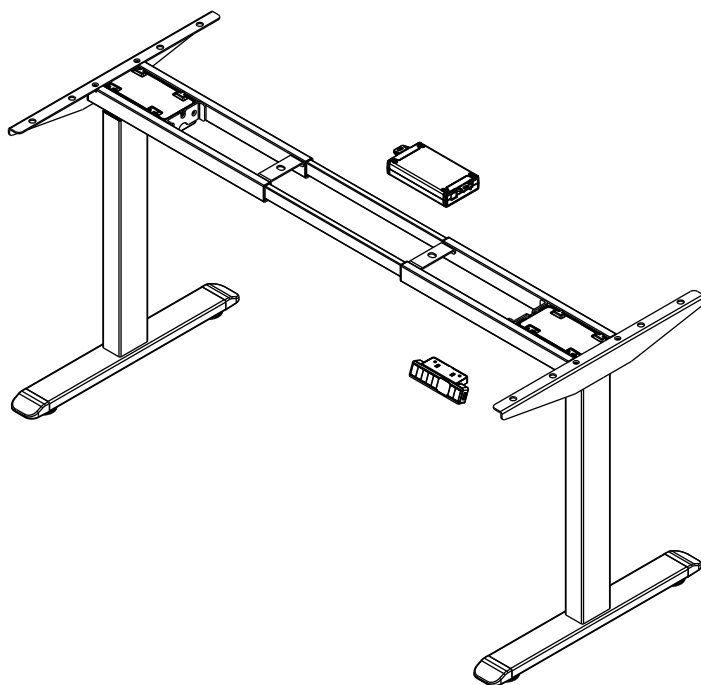



Caution

- Hand tighten all hex-head screws. Use power drill on self-tapping screws only.
- Always check that screws used to attach components to the worksurface are not too long for the thickness of the surface.

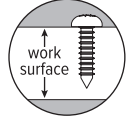

Please review these instructions before beginning the installation. Use the illustrations below to check that all components needed for your installation were provided with your order. Do not discard the packaging until the product works to your satisfaction.

Components and tools

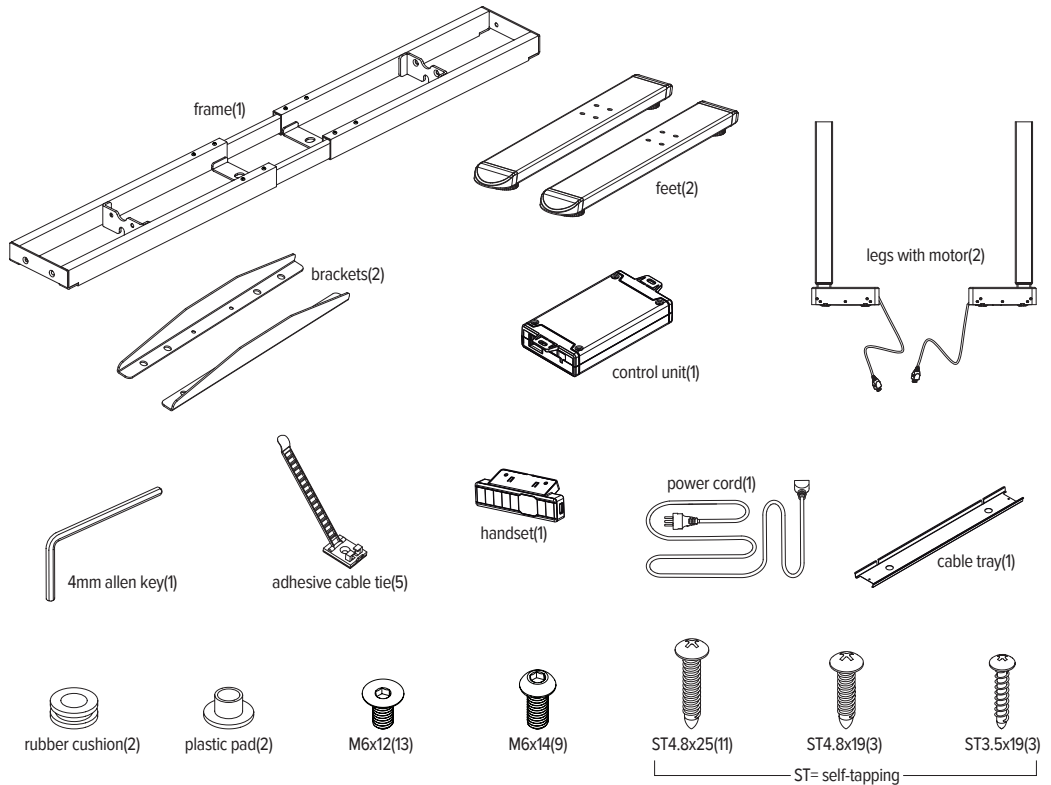

Additional tools required

- power drill with Phillips #1 and #2 bits

Step #1: adjust frame width

- Place the worksurface facing down on a soft, clean surface.
- Center the frame, front to back on the worksurface.
- Adjust the width of the frame.
 - Use the 4mm Allen key to loosen all eight M6x10 screws in the cross channels.
 - Expand the frame so that its ends are 1" to 2" from the edges of the table.
 - Tighten the M6x10 set screws to hold the width.

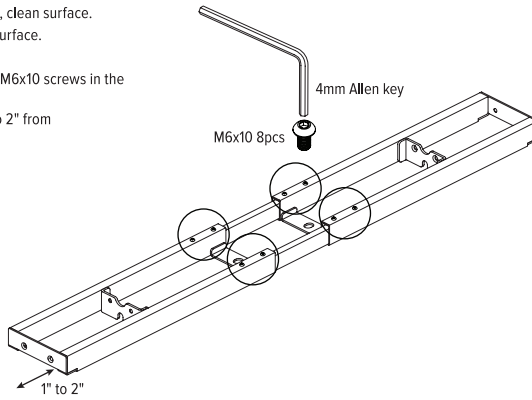

Step #2: attach the legs

- Attach each leg to the frame with four M6x12 screws per leg, as shown.

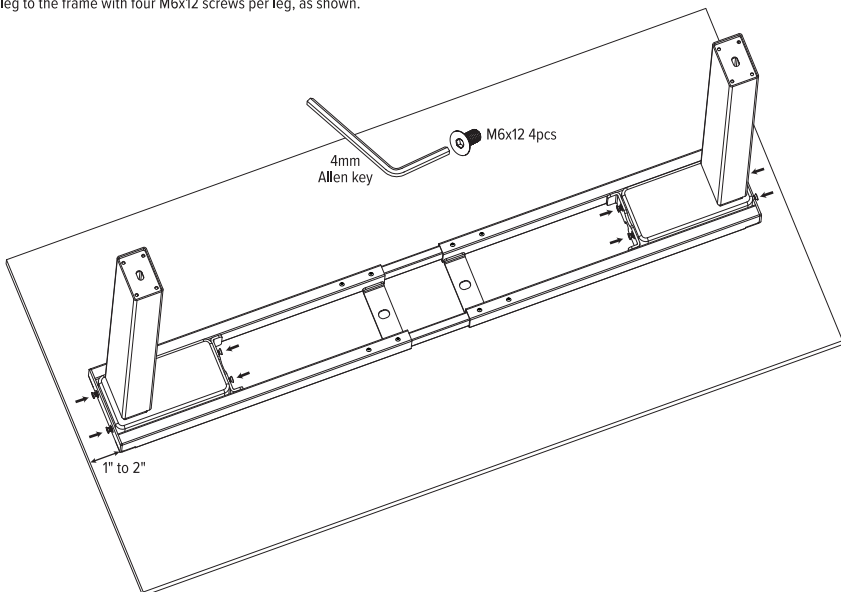

Step #3: attach feet

- Attach a foot to each leg with four M6x14 screws per foot.

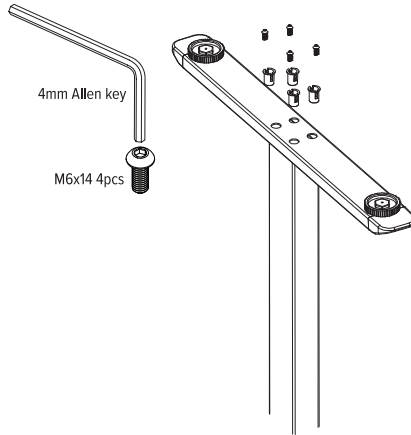

Step #4: attach brackets

- Turn the frame upright.
- Attach the brackets to the end of the frame with two M6x12 screws per bracket.

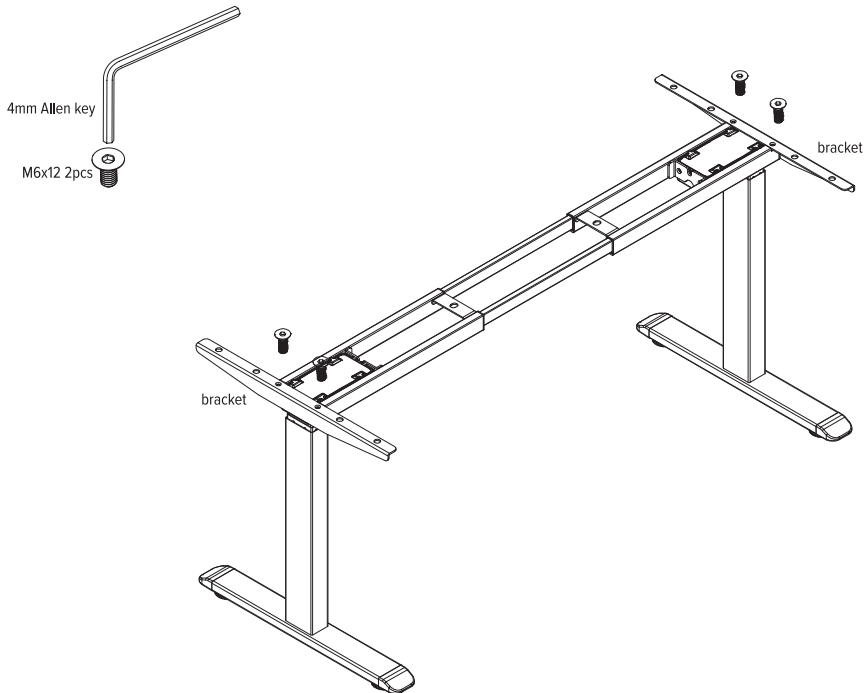

Step #5: secure frame to worksurface

- Turn the assembly over and place the frame and brackets onto the worksurface.
 - Center the assembly on the worksurface, front to back and side to side.
- Using a power drill and #2 Phillips bit, secure the frame to the worksurface with ten ST4.8x25 self-tapping screws.
 - Screw through the ten plastic pads/rubber cushions.

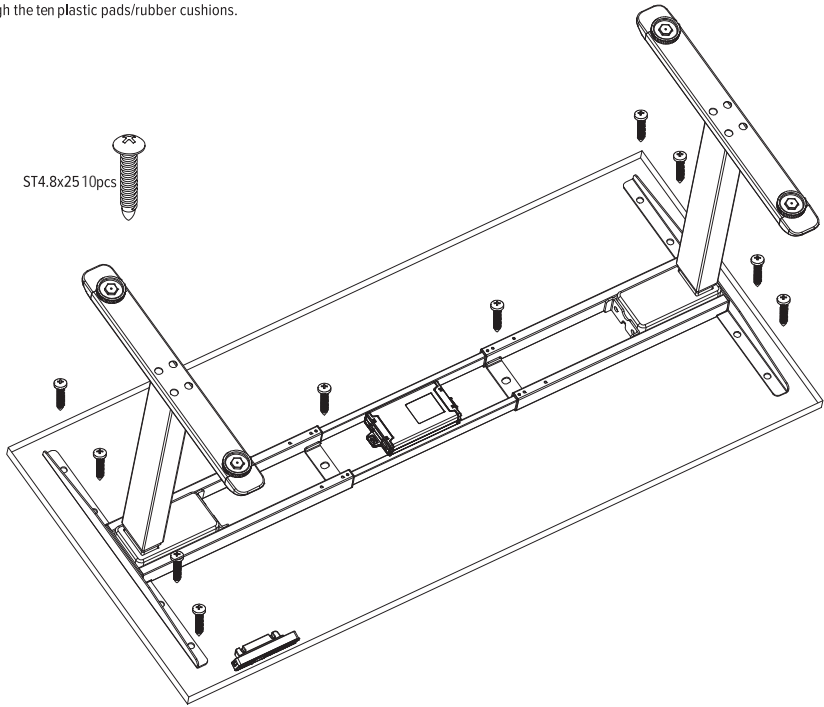

Step #6: attach control unit and handset

- Attach the control unit to the worksurface with two ST4.8x19 self-tapping screws.
 - Position the control unit on the rear side of the frame's cross channels in a location where 1) its ports can be reached by the cables from the legs and handset, and 2) the power cord will be convenient to an outlet or power strip.
- Attach the handset to the worksurface with two ST3.5x19 self-tapping screws.
 - Position the handset flush with the front edge of the worksurface, on the left or right side according to user preference. Be sure the cable can reach its port on the control unit.

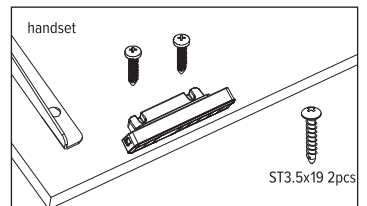
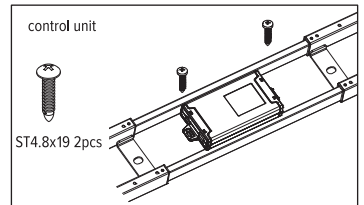

Step #7: connect cables and cords

- Connect the cables from the handset and each of the leg motors to their ports on the control unit.
- Plug the female end of the power cord into the control unit.
- Place the adhesive cable ties on the bottom of the worksurface to control the cables and power cord.
— **Important:** The cables and cord must not dangle under the table where they may present a hazard to the user or may accidentally be pulled from their connections.

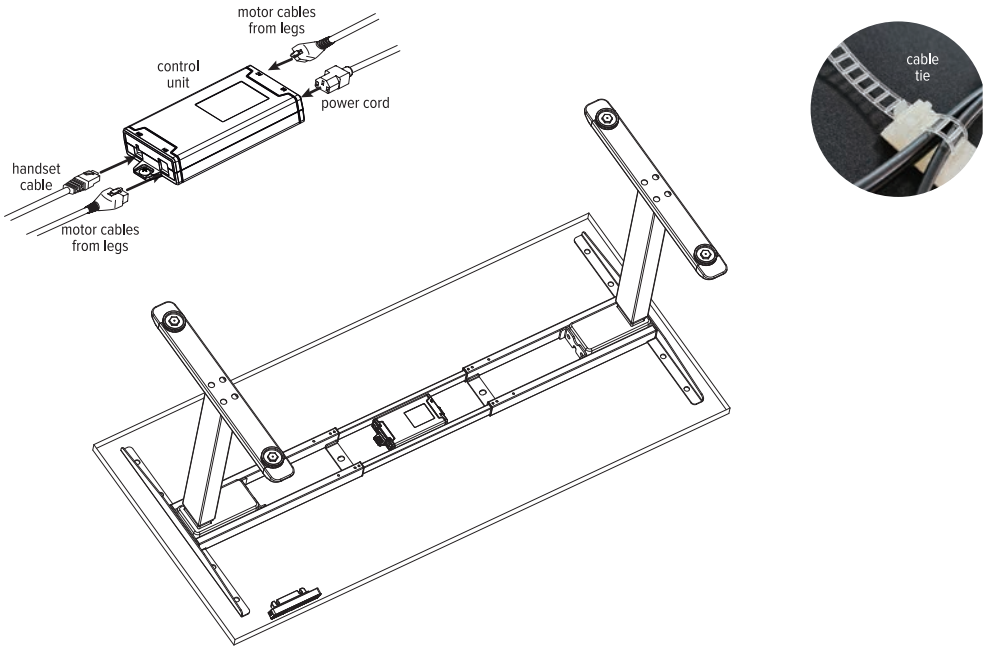

Step #8: connect cable tray

Attach the cable tray to the beam.

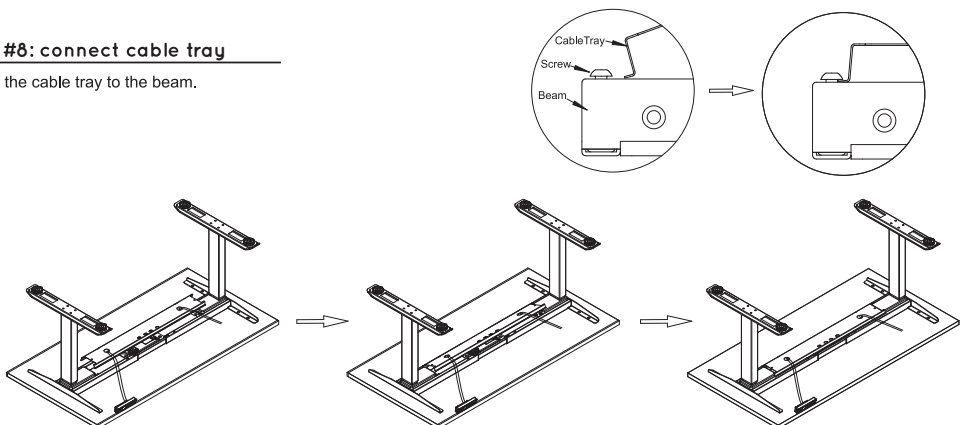

Step #9 : activate motors and test operation

Activating and Troubleshooting:

The process for activating your memory keypad can also be used to reset your desk and fix most issues:

1. Begin by pressing and holding the "up" and "down" buttons at the same time.
2. Continue to hold as the frame lowers itself all the way down (if extended).The display will then flash "E00" followed to the lowest height. You will hear a slight beep sound followed by a brief flash on the display.
- 3.Press the "up"button once to engage the motors - your desk should be activated and ready to go.

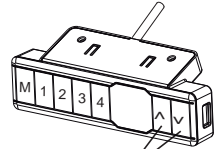

press both to
activate motors

Note:

If initialization is interrupted by releasing buttons prematurely(display will read"E00")and/or if desk does not begin moving,repeat STEP#9.

Gyro Sensor Anti-collision System ensure safety during lifting, it will run in the opposite direction when encountering obstacles or user slightly tap the table top edge(display will read"E03"or "E04"),or when the control box is not installed properly(display will read"E04").Please remove obstacles or check the control box installation to ensure that the gyro sensor anti-collision system works properly.

Step #10:setting the memory presets

Setting the Memory Presets :

To preset a specific height(s), press and hold the "M" button until the display flashes, then select the number you would like to associate with that height. Your handset will remember the exact height for each designated number even if power is lost.

Step #11 : dynamic display

Setting your desk's height measurement from inches to centimeters:

1. Press buttons "1", "2" and "M" at the same time for five seconds. Letters "C-1" should appear.
2. Press the "1" button and you'll see "C" displayed. You handset is now in centimeters.

Revert back to inches from centimeters:

- 1.Repeat above step1
- 2.Press button "2" complete inch system set.

Step #12: complete the installation

- With the assistance of a helper, turn the table upright and place it in its final position.
 - **Important:** There must be one inch of clearance on all sides of the worksurface (and other moving parts) to ensure free, unobstructed movement.
- If necessary, adjust the leveling glides on the feet to level the worksurface.
- Plug the power cord into an AC outlet.
- Re-activate the motors. See Step #9 above.

Note: Whenever the unit is unplugged or the power is cut, the motors must be re-activated.