

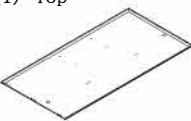

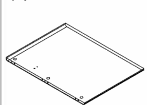



(1) Top  1PCS	(2) End Panel  2PCS	(3) Modesty Panel  1PCS	(A) Dowel  14PCS+1	(B) Cam Pin  12PCS+1	(C) Cam Lock  12PCS+1	(p) Cam Cover  12PCS+1	(D) Leg leveler  4PCS	(W) Grommet  2PCS
--	---	---	--	--	--	--	---	--

STEP 1

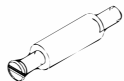

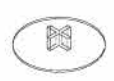
STEP 2

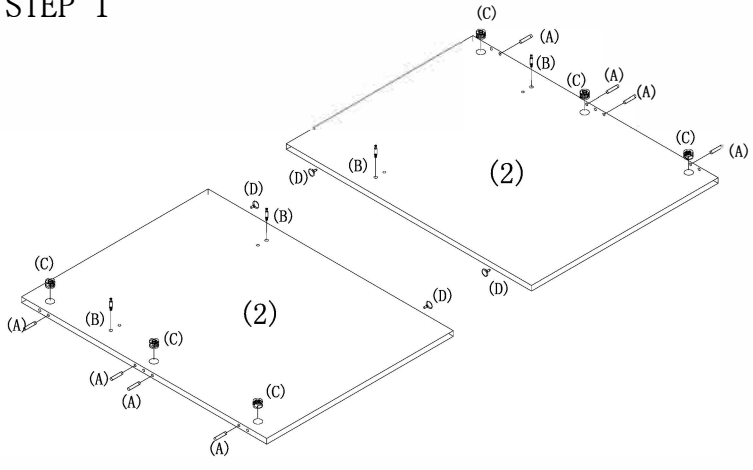
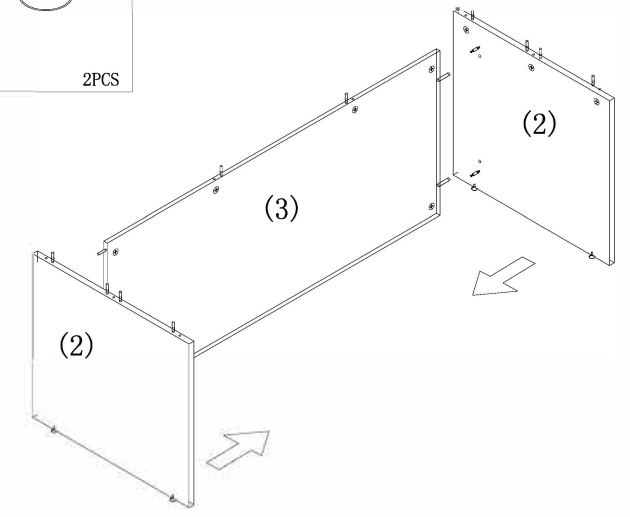
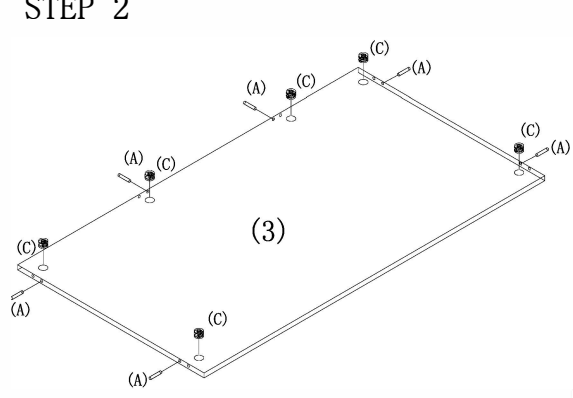

STEP 4

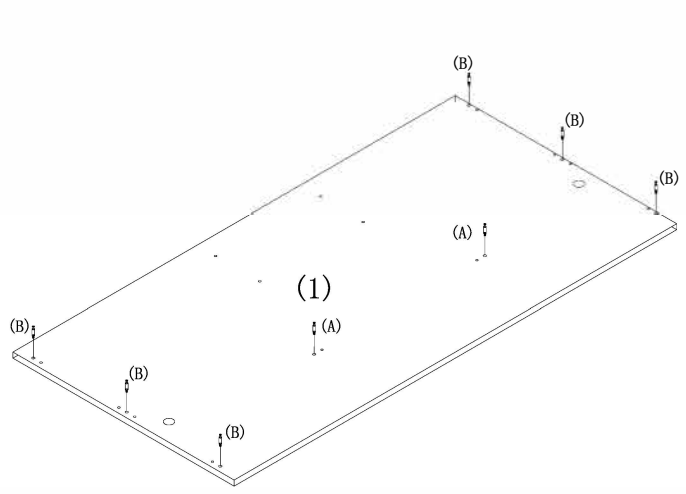

STEP 5

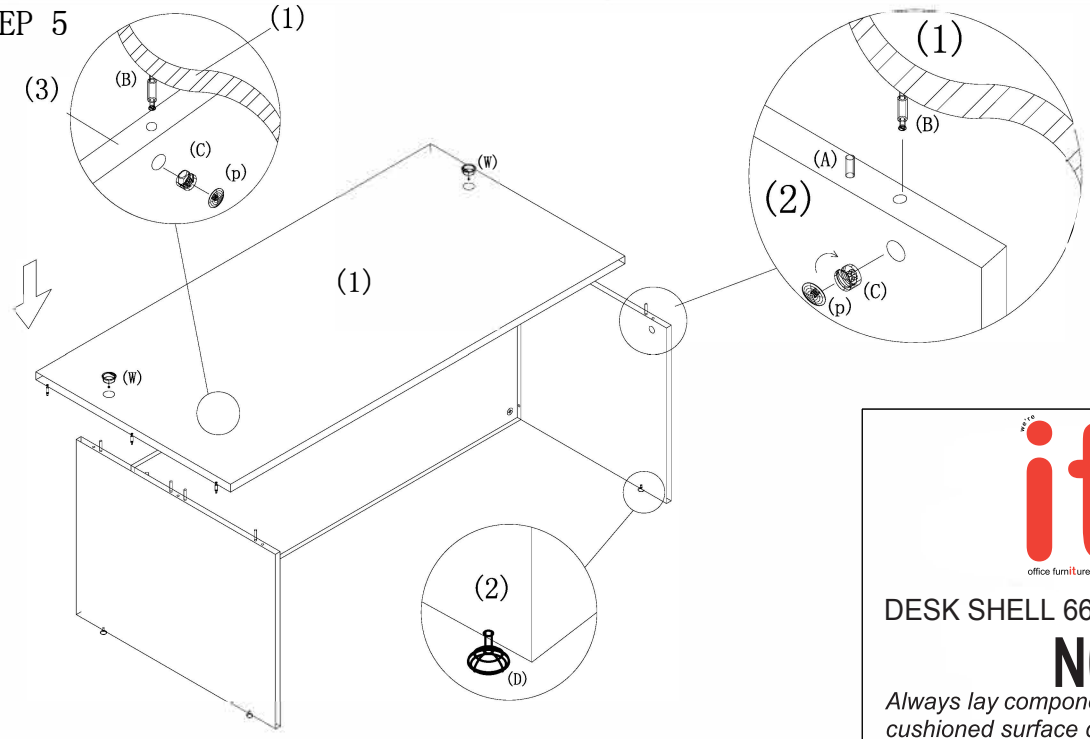

office furniture distributors

DESK SHELL 66"W x 30"D x 29"H

N02

Always lay components on a clean, soft-cushioned surface during assembly.