

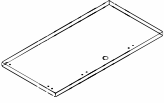

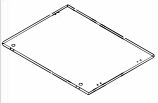

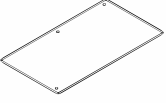

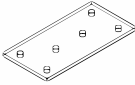

(1) Top  1PCS	(2) End Panel  1PCS	(3) Modesty Panel  1PCS	(S2) Flat Bracket  2PCS	(A) Dowel  6PCS+1	(B) Cam Pin  6PCS+1	(C) Cam Lock  8PCS+2	(P) Cam Cover  8PCS+2	(W) Grommet  2PCS	(D) Leg Leveller  4PCS	(E2) Wood Screw  2PCS+1	(E4) Wood Screw  12PCS+2	(N) Cam Cover  6PCS+1	(Q) Plug  2PCS+1
--	---	---	---	---	--	--	--	--	--	--	---	--	---

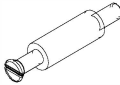
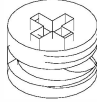
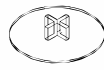
**STEP 1**



**STEP 2**

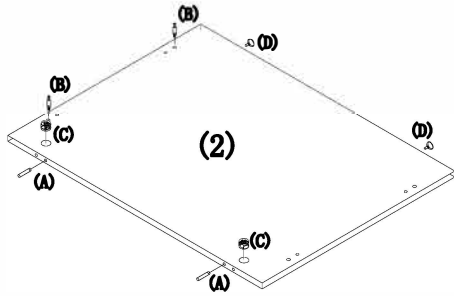
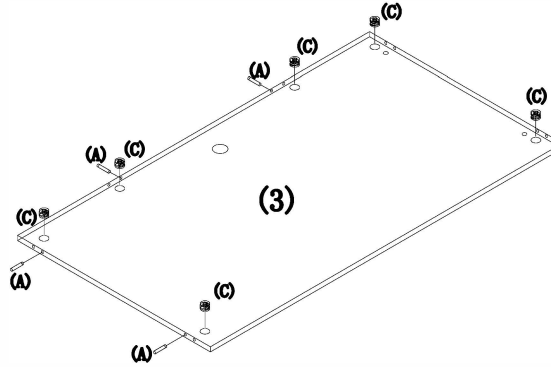

**STEP 3**

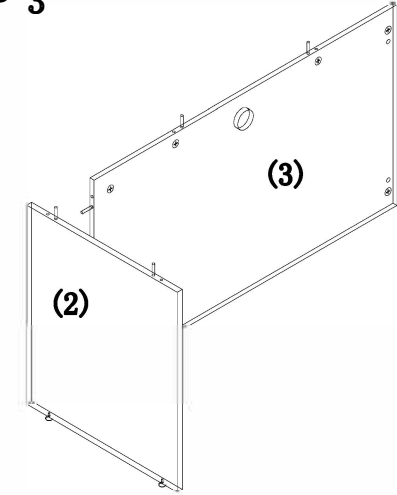

**STEP 4**

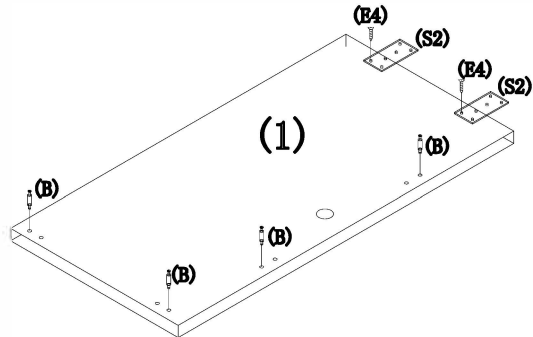

**STEP 5**

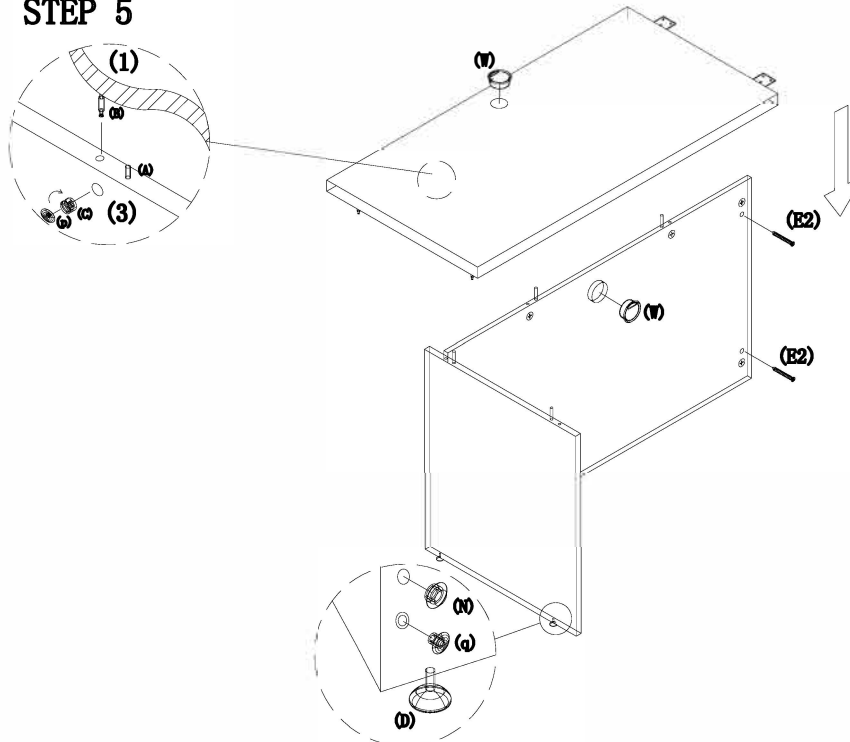

**it.**  
office furniture distributors

**RETURN SHELL 48"W x 24"D x 29"H**

**N45**

*Always lay components on a clean, soft-cushioned surface during assembly.*