

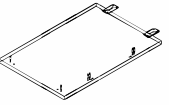

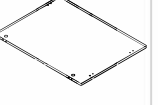

| | | | | | | | | | | | | | |
|--|---|---|---|---|--|--|---|---|--|---|--|---|--|
| (1) Top  1PCS | (2) End Panel  1PCS | (3) Modesty Panel  1PCS | (S2) Flat Bracket  2PCS | (A) Dowel  6PCS+1 | (B) Cam Pin  6PCS+1 | (C) Cam Lock  8PCS+2 | (p) Cam Cover  8PCS+2 | (W) Grommet  2PCS | (D) Leg Leveller  4PCS | (E2) Wood Screw  2PCS+1 | (E4) Wood Screw  12PCS+2 | (N) Cam Cover  6PCS+1 | (q) Plug  2PCS+1 |
|--|---|---|---|---|--|--|---|---|--|---|--|---|--|

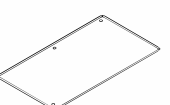
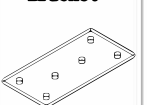
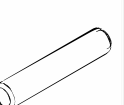
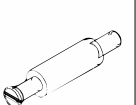
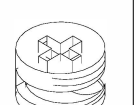
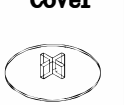

it.
office furniture distributors

RETURN SHELL 42"W x 20"D x 29"H

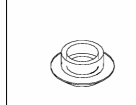
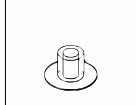
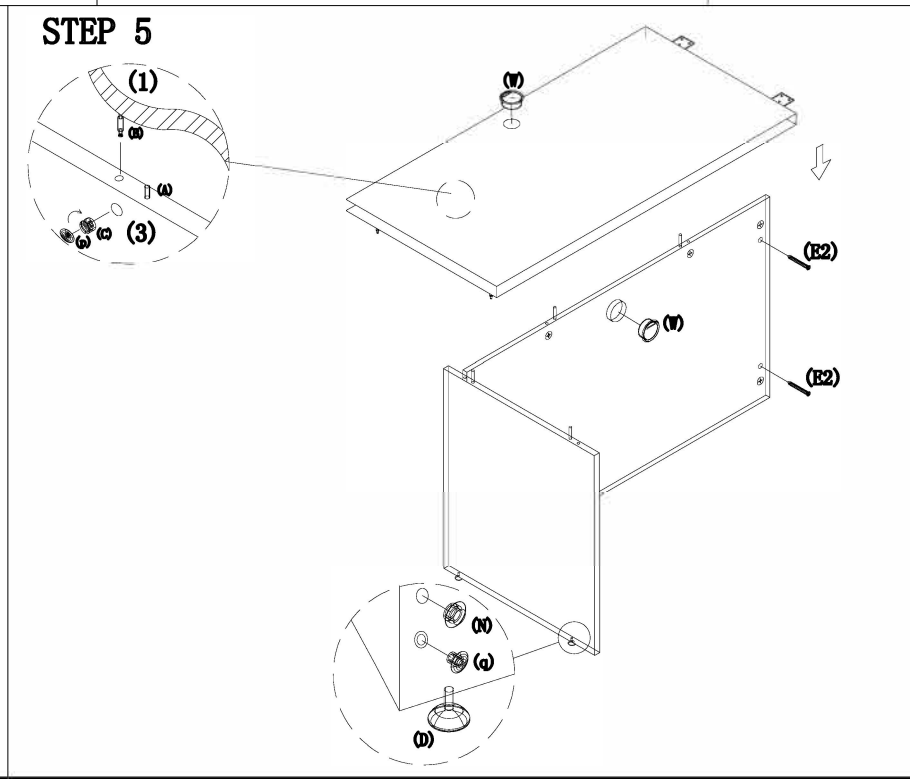
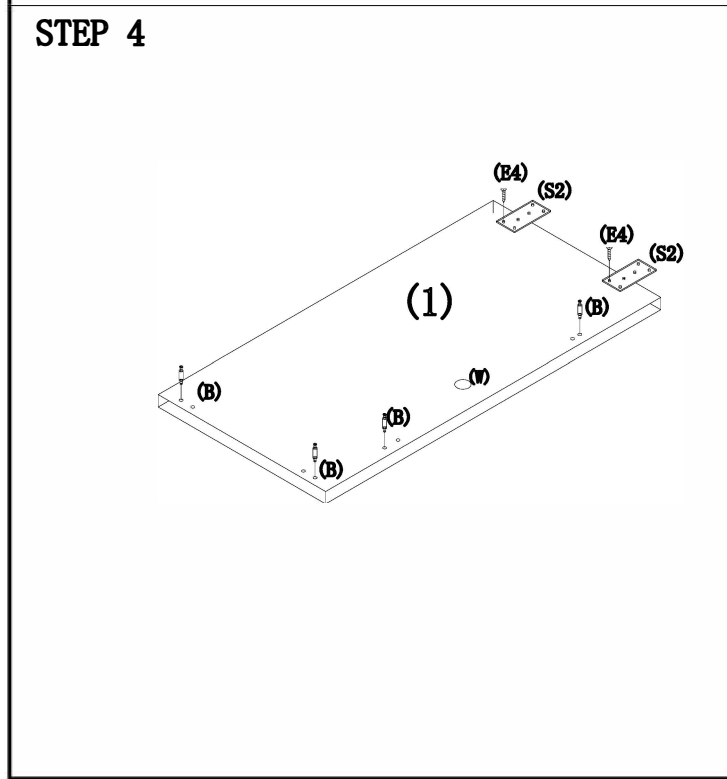
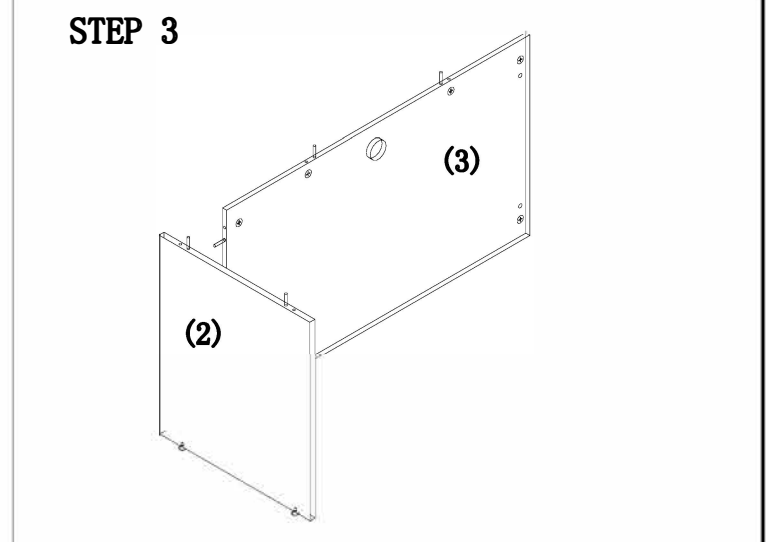
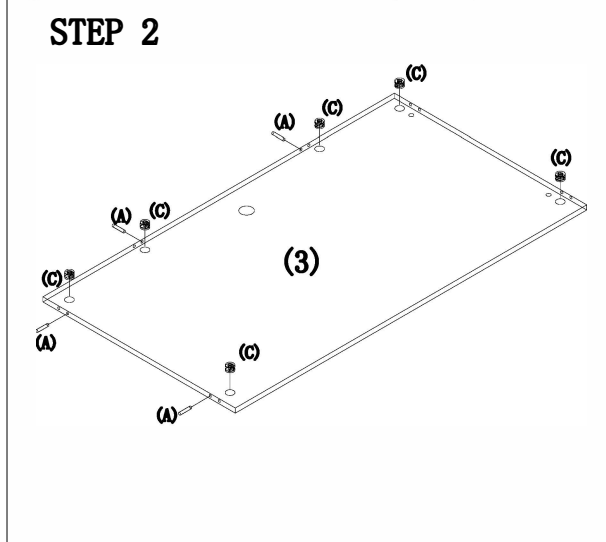
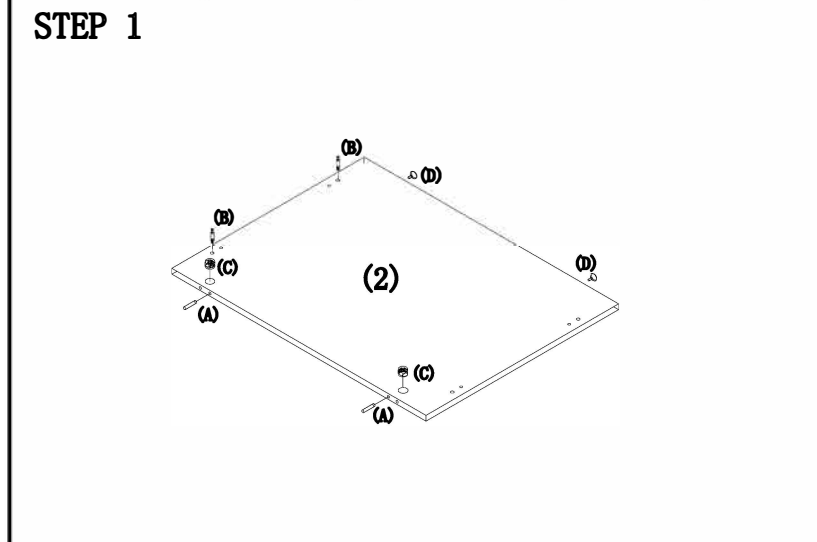
N46

Always lay components on a clean, soft-cushioned surface during assembly.