

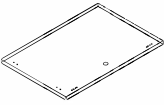

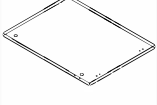

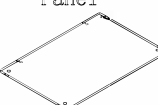

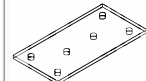
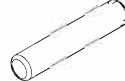
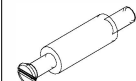
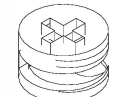

(1) Top  1PCS	(2) End Panel  1PCS	(3) Modesty Panel  1PCS	(S2) Flat bracket  2PCS	(A) Dowel  6PCS+1	(B) Cam Pin  6PCS+1	(C) Cam Lock  8PCS+2	(p) Cam Cover  8PCS+2	(W) Grommet  2PCS	(D) Leg Leveller  4PCS	(E2) Wood Screw  2PCS+1	(E4) Wood Screw  12PCS+2	(N) Cam Cover  2PCS+1	(q) Plug  2PCS+1
--	---	---	---	---	---	--	--	--	--	--	---	--	---

STEP 1



STEP 2

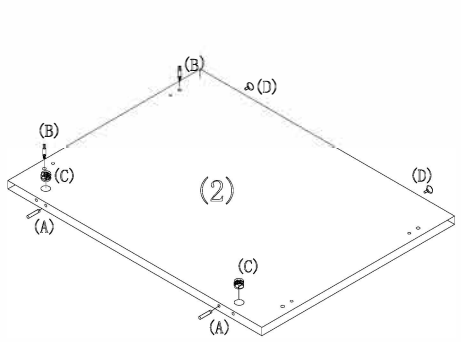
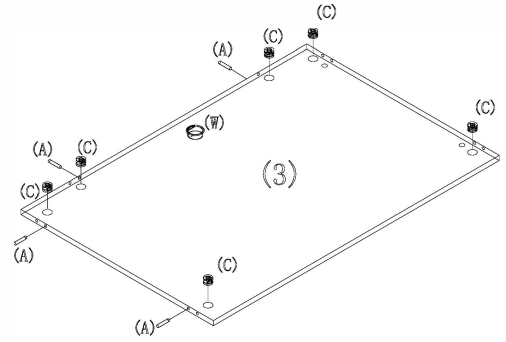

STEP 3

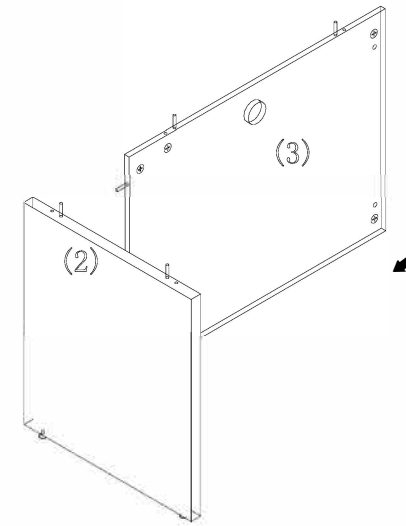

STEP 4

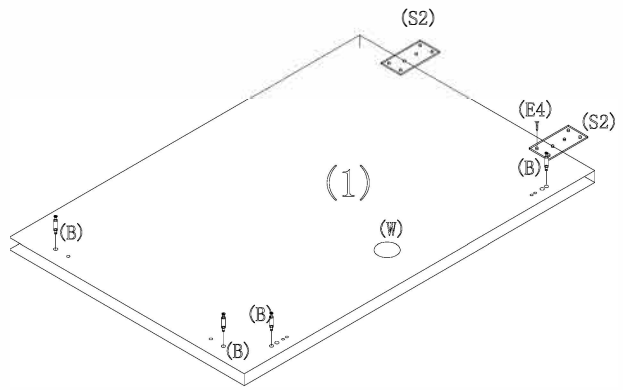

STEP 5

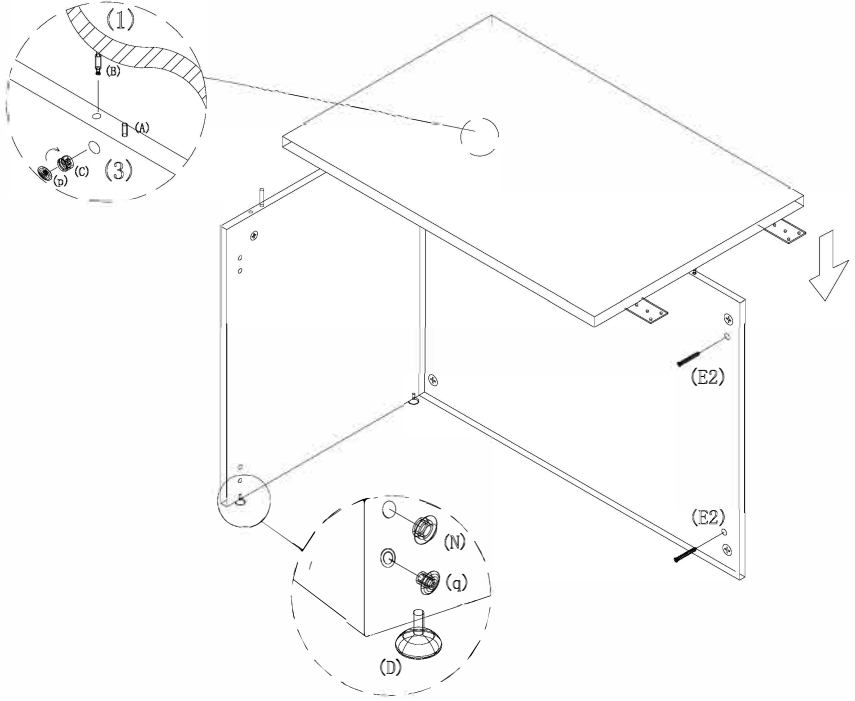

it.
office furniture distributors

RETURN SHELL 35"W x 24"D x 29"H

N92

Always lay components on a clean, soft-cushioned surface during assembly.